

ROTARY SOLUTIONS CATALOGUE



WAIKATO[®]
MILKING SYSTEMS



When you invest in a milking system, you want a system which is superbly designed, robust, reliable and easy to use.

waikatomilking.com

Growing the value of dairy





HOW TO USE THIS CATALOGUE

This catalogue has been designed to help you find the perfect rotary solution for your farm’s unique dairying challenges and requirements.

To make it easy for you to navigate this catalogue, we’ve divided it into **seven sections** that cover the **areas on farm that you might be looking for solutions in**. These range from our world-leading Rotary Milking Systems, through to our Labour Saving & Productivity, Nutrition & Feeding, Cow Health, Mating & Fertility, Milk Production & Udder Health, and Milk Quality & Milk Cooling solutions. You will find products duplicated in multiple sections throughout this catalogue, this shows how **products cross over into many areas and work hand-in-hand**.

Before you start exploring our range of rotary solutions we’d recommend taking the time to learn more about our company on the following pages, and how we can help you grow the value of your dairy today and well into the future.

ROTARY SOLUTIONS CATALOGUE

Contents	3	Cow Health	75
Our Company - Our History	4	CowTRAQ™ Collars	76
Why Choose Us	5	TracHQ™ Software	80
		SmartD-TECT - Udder Health Detection	84
Systems	7	SmartSPRAY - Automatic Teat Spray System	86
Evolution of Rotary Milking Systems	8	WalkoverSPRAYER - In Race Teat Spray System	88
Why choose a Rotary Milking System	9	Waikato Spray Arm	90
Orbit Introduction	10	Sort Gates	92
Orbit 2500	12		
Orbit 5500	14	Mating and Fertility	95
Orbit 9500 / 9500s	16	CowTRAQ™ Collars	96
Centrus Introduction	18	TracHQ™ Software	100
Centrus 2500	20	Sort Gates	104
Centrus 5500	22		
Centrus 9500	24	Milk Production & Udder Health	107
Centrus 9500s	26	Electronic Milk Meter	108
Velocity Introduction	28	Yield Indicator	110
Velocity 9500	30	320 Standard Milking Cluster	112
Systems Comparisons	32	320 High Performance Milking Cluster	113
		SmartSPRAY - Automatic Teat Spray System	114
Labour Saving & Productivity	33	WalkoverSPRAYER - In Race Teat Spray System	116
ECR-S ACR's / Detachers	34	SmartD-TECT - Udder Health Detection	118
ECR Plus ACR's / Detachers	36	ECR-S ACR's / Detachers	120
User Display	38	ECR Plus ACR's / Detachers	122
Cow Restraints - Cow Retention	39	DairyHQ™ Dairy Management System	124
320 Standard Milking Cluster	40		
320 High Performance Milking Cluster	41	Enhance Milk Quality & Milk Cooling	131
SmartD-TECT - Udder Health Detection	42	320 Standard Milking Cluster	132
SmartSPRAY - Automatic Teat Spray System	44	320 High Performance Milking Cluster	133
SmartWASH - Automatic Wash System	46	SmartSPRAY - Automatic Teat Spray System	134
CowTRAQ™ Collars	48	WalkoverSPRAYER - In Race Teat Spray System	136
DairyHQ™ Dairy Management System	52	Waikato Spray Arm	138
		Plate Heat Exchanger	140
Nutrition & Feeding	59	SmartWASH - Automatic Wash System	141
CowTRAQ™ Collars	60	Ice Bank - Refrigeration Unit	142
TracHQ™ Software	64	Water Chilling - Refrigeration Unit	143
DairyHQ™ Dairy Management System	68	Glycol Snap Chilling - Refrigeration Unit	144
		Milk Vat Chilling - Refrigeration Unit	145
		Our Guarantee	146
		Things to Consider	147
		Planning Your Dairy	148



HUMBLE BEGINNINGS OVER 50 YEARS AGO

Waikato Milking Systems was founded with a solid commitment to design, develop and manufacture evolutionary milking equipment for dairy farmers - worldwide.

OVER 50 YEARS AGO... born in New Zealand's dairy heartland, our pioneering spirit has earned us an international reputation for innovation and excellence in dairying, animal welfare, food production and environmental sustainability.

At our state-of-the-art global headquarters, we design and manufacture dairy technology that enables farmers around the world to grow the value of their dairy - by running more productive, cost-efficient and profitable operations.

We stand behind our solutions, and all around the world farmers know they can rely on our products and systems to perform, and last the distance.

WE UNDERSTAND FARMING

Because we understand farming - from small family-owned farms, through to large-scale intensive 24/7 operations, and from cows to goats and sheep - we are able to deliver products and systems to suit any budget, and any farming type - and we can customise solutions to fit any farm's specific requirements.

What our farmers value, is different for each and every one of them... and our world, and our industry is changing. So we're always listening, collaborating, and looking ahead with them, continually innovating, designing and engineering solutions to grow their success, and our industry's.

Waikato Milking Systems' global headquarters and engineering divisions are located in New Zealand and we have offices and warehouses in Australia, USA, United Kingdom, Ireland and China with agents in every dairying nation in the world.

WHY CHOOSE US

Through the development of smart technologies and the future of milking technology, we are enabling farmers throughout the world to make the most informed decisions for their farm today, and in the future:



WE ARE PIONEERING THE SEMI-ROBOTIC REVOLUTION

With a strong focus on innovation, we've set our sights on achieving ambitious goals to break existing productivity barriers and lead our farmers into the future with new ground-breaking technologies.

By taking a milking science based approach, we are pioneering a semi-robotic revolution with the goal of significantly reducing the workload at milking time, so an operator can milk more cows per hour with less labour. These smart technologies will eliminate the challenges of manual operations, streamline the milking process and improve hygiene and milk quality.

By focussing on significantly reducing the effort required in milking, we will also increase the well-being of operators while improving their dairy performance and productivity.



OUR LARGE COMMERCIAL FARMS AND CUSTOMERS TRUST US THE WORLD OVER

Our unwavering commitment to continually push the boundaries in the design of high-performing milking solutions and dairy technology, is why our world-leading systems are trusted by large commercial farmers the world over.

With the most comprehensive range of rotary technologies for cows, sheep and goats available, our proven systems have been developed for high yielding herds, so our commercial customers can run more productive, cost-efficient and profitable operations 24/7. Manufactured from high-performance materials, our composite rotary platforms are structurally stronger, significantly lighter, and longer-lasting to withstand the harshest of milking environments.



WE TRACK AND MONITOR YOUR MOST VALUABLE ASSETS

To allow you to maximise your herd performance and efficiency we're continually developing smart technologies that drive real-time, data-driven insights to enable you to make better, more informed management decisions to improve the overall productivity and profitability of your farm.

By tracking and monitoring individual cows and herd performance trends 24/7, we are empowering you to "know your cows, track your herd" so you can take control of cow health, heat detection and nutrition management - to maximise labour efficiency and improve your bottom line.



WE HELP DRIVE DAIRY PERFORMANCE AND PRODUCTIVITY THROUGH SMART-TECH

To drive dairy performance, production and productivity, smart technologies are at the very core of our product design and development. The collection of individual cow and herd data, combined with a complete overview of the milking system is more important than ever. By providing you with insights and intelligent, adaptive automation at your fingertips, you can improve your milking productivity and performance.

Increasing milking efficiency and speed, and reducing the effort required at milking time promotes an efficient, natural let-down response to improve milk quality and creates a much calmer operator-friendly environment. By providing you with the tools to automatically collect and monitor milking data so you know your animal's production data every day - we put you in full control, right where you need to be.

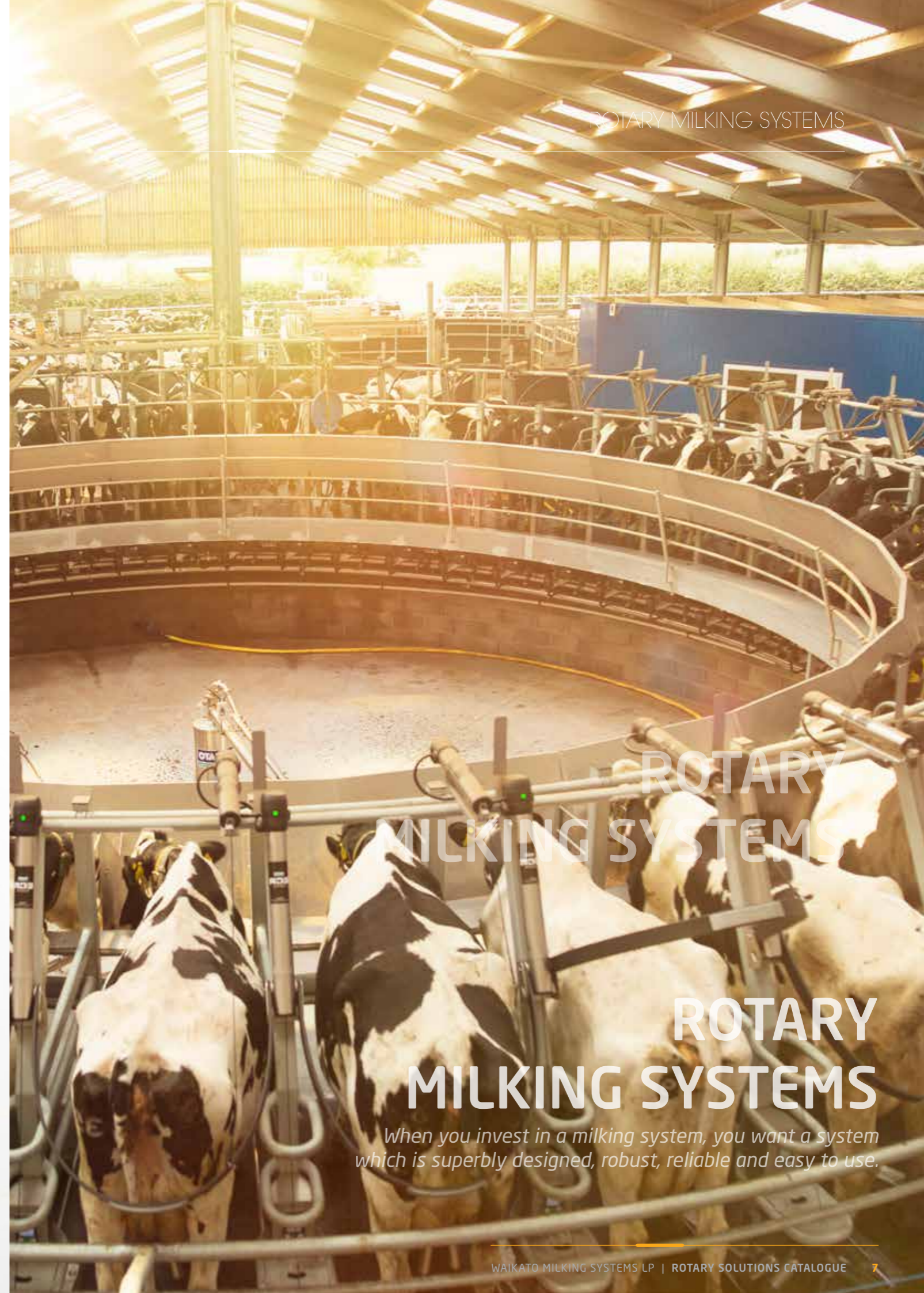

ROTARY MILKING SYSTEMS

ROTARY MILKING SYSTEMS

When you invest in a milking system, you want a system which is superbly designed, robust, reliable and easy to use.



KIWI INGENUITY HAS BEEN REVOLUTIONISING THE DAIRY INDUSTRY GLOBALLY FOR MORE THAN 100 YEARS...

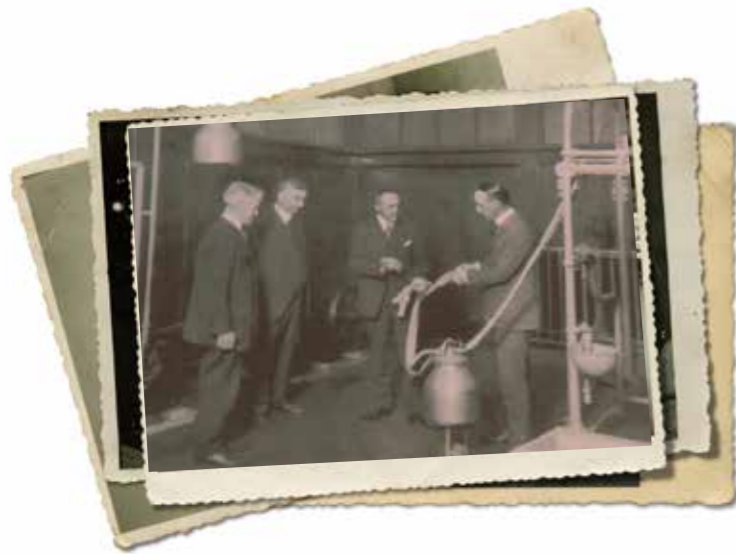

1917

- In 1917 **Norman Daysh**, a little-known farmer from Pahiatua revolutionised dairy farming around the world by launching the **first mechanised milking system**.

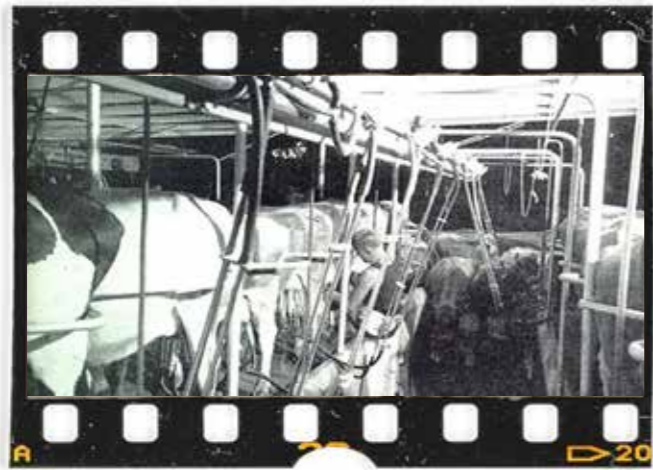

1952

- In 1952, after being tired of stooping down to attach the cluster to the cow, Waikato farmer **Ronald Sharp** invented what is now known as the **herringbone cowshed**.

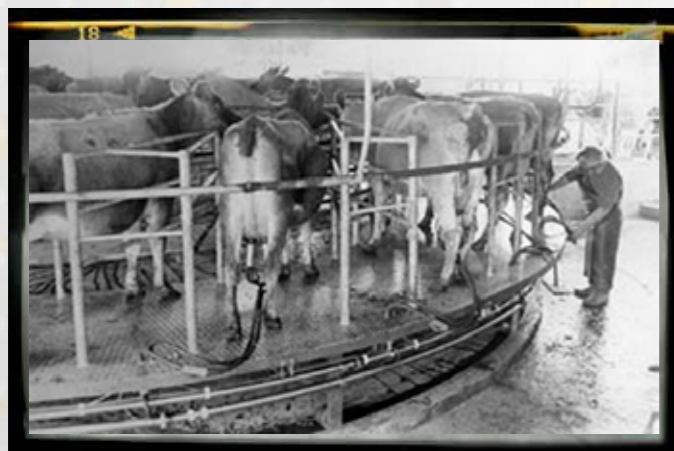

1968

- Then in the late 1960s, Taranaki farmer **Merv Hicks** turned milking around with his invention of the **rotary milking platform**. The turnstile design was a revolution in breaking the barriers of how many cows could be milked in an hour.

WHEN YOU INVEST IN A MILKING SYSTEM, YOU WANT A SYSTEM WHICH IS SUPERBLY DESIGNED, ROBUST, RELIABLE AND EASY TO USE.

A modern rotary milking system coupled with key automation technology can provide critical advantages to help fine tune and improve the overall performance of your unique dairy operation. Increases in herd sizes has prompted recent investment in rotary technology as dairy operators look for more efficient systems to milk their herd. The global labour shortage has also fueled more interest in rotary systems because of their ability to milk more cows with fewer people.

Platform performance

Rotary platforms can range from 28 to 80 points although some have been manufactured in larger sizes, up to 140 points for commercial dairy farms. The number of points designed for a rotary depends on the size of the herd and any future plans for herd expansion. Research suggests a rotary system becomes the dairy type of choice once herd sizes grow beyond 500 cows. A rotary can be fine tuned to achieve optimum milking time by adjusting the rotation speed of the platform to meet the dairy farm's milking strategy.

Research and development

There has been extensive research and development to refine rotary milking systems to meet the needs of a modern dairy farm operator. Coupled with milking automation technology such as automatic cup removers, automatic teat spray and auto sorting, rotary systems can deliver higher efficiency and productivity outcomes for your dairy operation. More advanced automation options can be added later on to gain even more efficiencies, such as milk meters, yield indicators, advanced pulsation systems with teat health detection capability and auto plant wash systems.

Rotary milking system solutions provide higher gains for farmers but with lower labour requirements, providing more time for staff to attend to other important jobs outside of the milking parlour.

Cow comfort and cow flow are paramount at milking time and rotary systems can be configured for quiet operation which makes for a more relaxed environment for the animals and the operator to work in. Strategic design and placement of entry and exit points ensure good cow flow less affected by operator-animal interaction.

ORBIT CONCRETE MILKING SYSTEMS

Providing a clean, fast milking environment, excellent cow flow with easily accessible milking equipment.



INCREASED EFFICIENCY, REDUCED LABOUR COSTS - ORBIT'S ARE SOLID, PROVEN AND RELIABLE

Orbit Concrete Rotary Milking Systems have been serving dairy farms around the world for nearly quarter of a century and continue to be a popular choice among family orientated farms as well as commercial dairy operations.

The strength and integrity of an Orbit Concrete Rotary Milking System has earned a reputation for reliability, longevity and proven technology, delivering excellent return on investment.

An Orbit is designed to provide a safe, clean and fast milking environment for the animals and the operator. This ensures cow flow on and off the platform is excellent and the milking equipment is easily accessible for the operator, both elements working together to optimise milking time and milk quality.

Orbit rotary milking systems are designed to integrate seamlessly with the range of Waikato Milking Systems automation technology. The modular design means the operator can add new automation options when the time is right, whether that be to meet herd expansion plans or simply when the budget allows.



With a well-earned reputation for more than 25 years, concrete rotary platforms have served the dairy industry well. Waikato Milking Systems Orbit Concrete Milking System is a recognised leader and has proven over time to be the platform of choice for customers around the world.



Easy to install, easy to use

The Orbit's SmartFIT mounting systems allows the milking machine equipment to be quickly and accurately attached to the rotary platform. Bolting on instead of welding reduces chance of corrosion.



Fast, quiet and efficient milking

The Orbit's design ensures excellent cow flow at entry and exit points providing a safe and calm working environment for the operator and the animals. Unique deck ports allow for ideal cluster alignment and easy cluster application.



Superior protection of milking equipment

The 2.7m width of the Orbit platform offers excellent protection for milking and electronic equipment. The deck slopes outwards which ensures effluent runs to the outside of the platform and an effective lubrication system keeps the 100mm concrete deck turning, reliably, at each milking time.



Full compatibility

The Orbit is compatible with the range of Waikato Milking Systems automation technology to help optimise your dairy operation. Our Research and Development team continues to test new automation equipment to make further advances in efficiency and productivity for dairy farms.



ORBIT 2500

Create a clean and efficient milking environment with the Orbit 2500 entry-level milking system.

SOLID, PROVEN AND RELIABLE.

The Orbit 2500 is an entry-level milking system without automation that utilises solid, proven technology to provide you with a clean and efficient milking environment.

Recognised for its strength and integrity, the design of the Orbit rotary concrete platform ensures excellent cow flow on and off the platform and provides easy access to milking equipment.

The platform is supplied with one operator console that includes safety devices and protection equipment, and the SmartFIT mounting systems allow for fast installation of equipment and easy maintenance.

The Orbit 2500 milking system is future-proofed, so it can be upgraded seamlessly with Waikato Milking Systems' dairy automation technology to increase your productivity and reduce labour costs when the time suits.

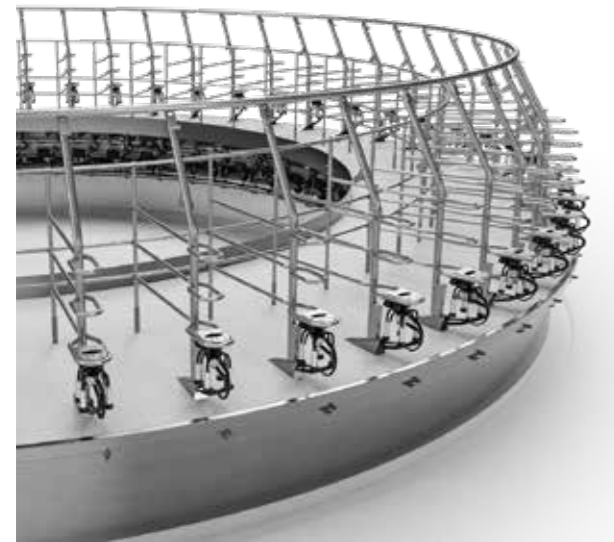

ADVANTAGES

The Orbit 2500 provides a solid, proven and reliable base model milking system to improve your milking parlour efficiency.



A quiet, efficient milking environment
An easy-to-use milking platform utilising solid, proven technology for quiet and efficient milking.



Excellent cow flow
The outward sloping deck allows for easy entry and exit, while ensuring effluent runs to the outside of the platform.



Designed for protection and efficiency
The wide deck provides protection for machinery, and the unique deck ports allow for better cluster alignment and application.



WHATS INCLUDED:

Platform:

- Rated Operating Duty per Day = 12 hrs
- Standard Stall width (875mm c/c outer rim)
- Standard Galvanised Stallwork
- Double Beam with nylon rollers at approx. 650mm spacing
- 100mm reinforced Concrete deck
- Drive Units & Cups On Controls
- Heavy duty galvanised RSJ sub frame
- Extra wide 2.7m platform
- Automatic lubrication system
- Full circumference control and emergency stop ropes
- Entry crush switch
- Entry D-Gate Assembly
- Full circumference rump and kick rail

Milking System:

- Milking point: *Clusters, Rubberware, Pulsators*
- Milk Handling: *Milk Pump, Milk Filter, Plate Heat Exchanger*, Chilling System**
- Vacuum System: *Vacuum pump, Vacuum Controller, Rotary Swivel, Interceptor*
- CIP / Wash System: *Wash Tub, Jetters, Recirculation Lines*
- Stainless Steel Componentry: *Rolled milk, pulsator & wash Lines, Receiver, Sanitary Trap*

* Some specifications may change depending on regional requirements

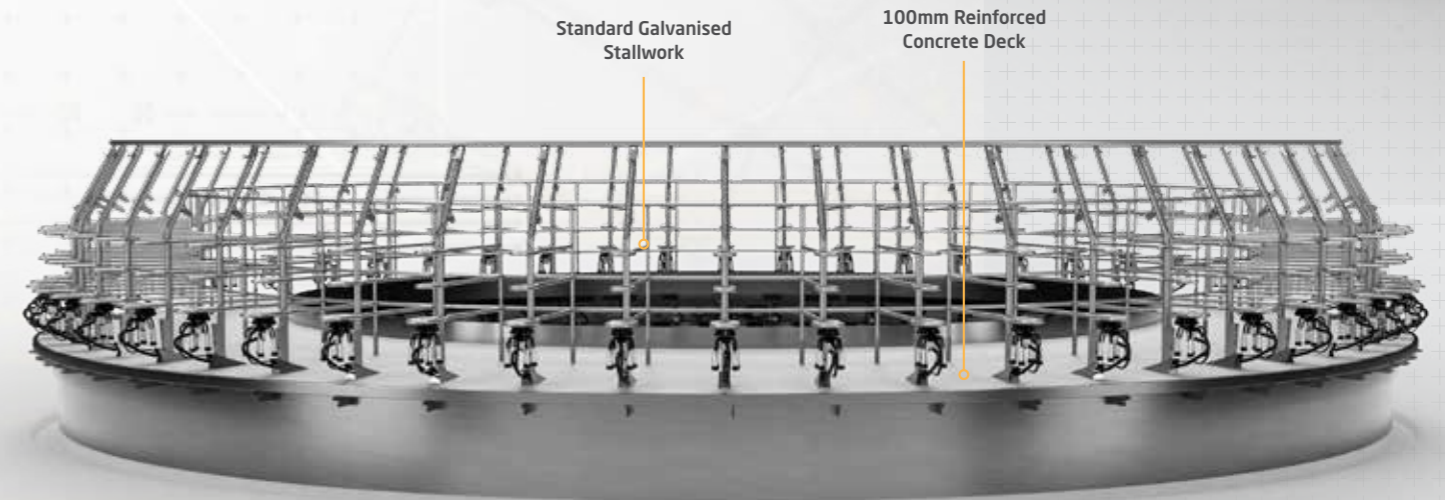

ORBIT 5500

Increase your efficiency and productivity with the Orbit 5500 milking system's entry-level automation technology.

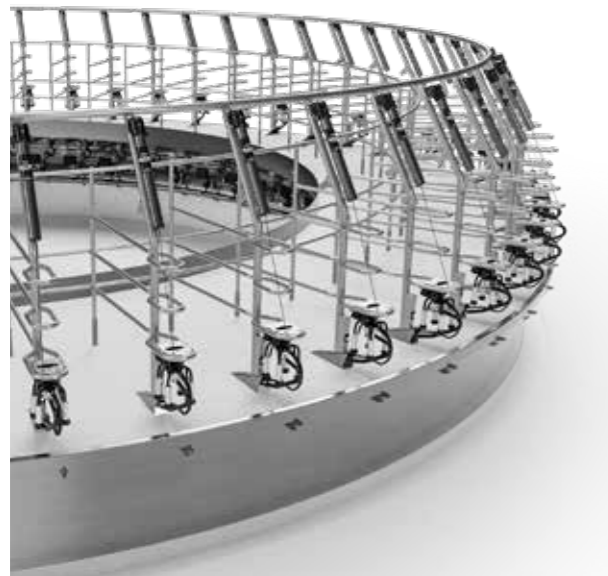

INCREASED EFFICIENCY, REDUCED LABOUR COSTS.

The Orbit 5500 builds on the entry-level milking system with the introduction of automated cluster removal to increase efficiency and reduce labour costs.

The Orbit rotary concrete milking system is known for its strength and integrity, and has been designed to ensure excellent cow flow on and off the platform.

Utilising solid, proven technology the Orbit 5500 milking system provides you with a quiet, clean and efficient milking environment with easy access to milking equipment.

One operator control console is supplied with the platform and includes safety devices and protection equipment, while SmartFIT mounting systems make equipment installation quicker and maintenance easier.

ADVANTAGES

The Orbit 5500 provides entry-level automation to increase your milking efficiency and reduce labour costs.



Excellent cow flow

The outward sloping deck allows for easy entry and exit, while ensuring manure runs to the outside of the platform.



Designed for protection and efficiency

The wide deck provides protection for machinery, and the unique deck ports allow for better cluster alignment and application.



A clean milk out and reduced labour

Labour-saving automatic cup removers offer a consistent milk out, while the User Display gives the operator real-time milking information and alerts.



WHATS INCLUDED:

Platform:

- Rated Operating Duty per Day = 12 hrs
- Standard Stall width (875mm c/c outer rim)
- Standard Galvanised Stallwork
- Double Beam with nylon rollers at approx. 650mm spacing
- 100mm reinforced Concrete deck
- Drive Units & Cups On Controls
- Heavy duty galvanised sub frame
- Extra wide 2.7m platform
- Automatic lubrication system
- Full circumference control and emergency stop ropes
- Entry crush switch
- Entry D-Gate Assembly
- Full circumference rump and kick rail

Milking System:

- Milking point: *Clusters, Rubberware, Pulsators*
- Milk Handling: *Milk Pump, Milk Filter, Plate Heat Exchanger*, Chilling System**
- Vacuum System: *Vacuum pump, Vacuum Controller, Rotary Swivel, Interceptor*
- CIP / Wash System: *Wash Controller, Wash Tub, Jetters, Recirculation Lines*
- Stainless Steel Componentry: *Rolled milk, pulsator & wash Lines, Receiver, Sanitary Trap*

Dairy + Animal Management:

- ACR's / Detachers

** Some specifications may change depending on regional requirements*

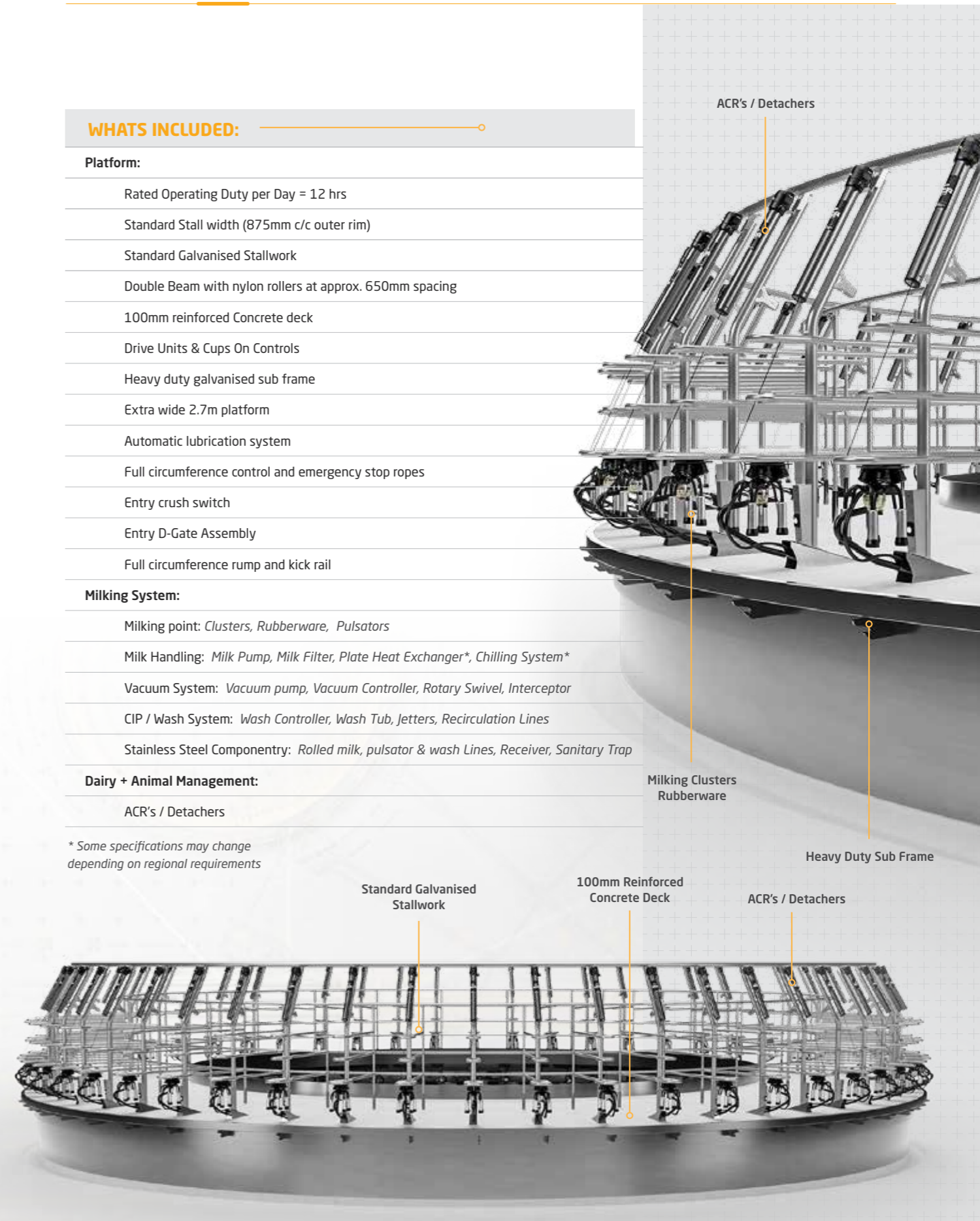

ORBIT 9500

Maximise your efficiency and save on time and labour costs with the Orbit 9500 milking system's full-suite of automation technology.

MAXIMISE YOUR MILKING EFFICIENCY & PRODUCTIVITY.

The Orbit 9500 milking system provides a full-suite of automation technology including automatic cup removers, automatic udder health monitoring and pre-milking stimulation, and milk yield to measure and record milk volumes.

The design of the Orbit concrete rotary platform utilises solid, proven technology to provide you with a clean and efficient milking environment with easy access to milking equipment. Recognised for its strength and integrity, the Orbit 9500 milking system ensures excellent cow flow on and off the platform.

The heavy duty stall work on the Orbit 9500 provides the next level of strength and durability for large scale 24/7 dairy operations or for operations with larger livestock. The 9500s with stainless steel heavy duty stallwork is resistant to chemical spray and effluent and is easier to clean and maintain.

Also available in:

9500s Heavy duty stainless steel stallwork

ADVANTAGES

The Orbit 9500 provides a full-suite of automation to increase your milking efficiency and reduce labour costs.



Excellent cow flow

The outward sloping deck allows for easy entry and exit, while ensuring manure runs to the outside of the platform.



Increase efficiency and reduce labour costs

A full automation suite gives real-time data along with animal health and performance monitoring.



Strong & durable extra comfort width stallwork

Designed for use in parlours with larger stock, providing a level of strength and durability for 24/7 milking.



WHATS INCLUDED:

Platform:

- Rated Operating Duty per Day = 24 hrs
- Extra Comfort Bail Width (980mm c/c outer rim)
- Heavy Duty Galvanised stallwork (or optional Stainless Steel)
- Double Beam with nylon rollers to suit 24/7 systems, at approx. 450mm spacing
- 100mm reinforced Concrete deck
- Drive Units & Cups On Controls
- Heavy duty galvanised sub frame
- Extra wide 2.7m platform
- Automatic lubrication system
- Full circumference control and emergency stop rope
- Entry crush switch
- Entry D-Gate Assembly
- Full circumference rump and kick rail

Milking System:

- Milking point: Clusters, Rubberware, Pulsators
- Milk Handling: Milk Pump, Milk Filter, Plate Heat Exchanger*, Chilling System*
- Vacuum System: Vacuum pump, Vacuum Controller, Rotary Swivel, Interceptor
- CIP / Wash System: Wash Tub, Jetters, Recirculation Lines
- Stainless Steel Componentry: Rolled milk, pulsator & wash Lines, Receiver, Sanitary Trap

Dairy + Animal Management:

- ACR's / Detachers
- Milking Point User Display
- Mastitis and Udder Health Detection
- Milk Metering
- Dairy Management System

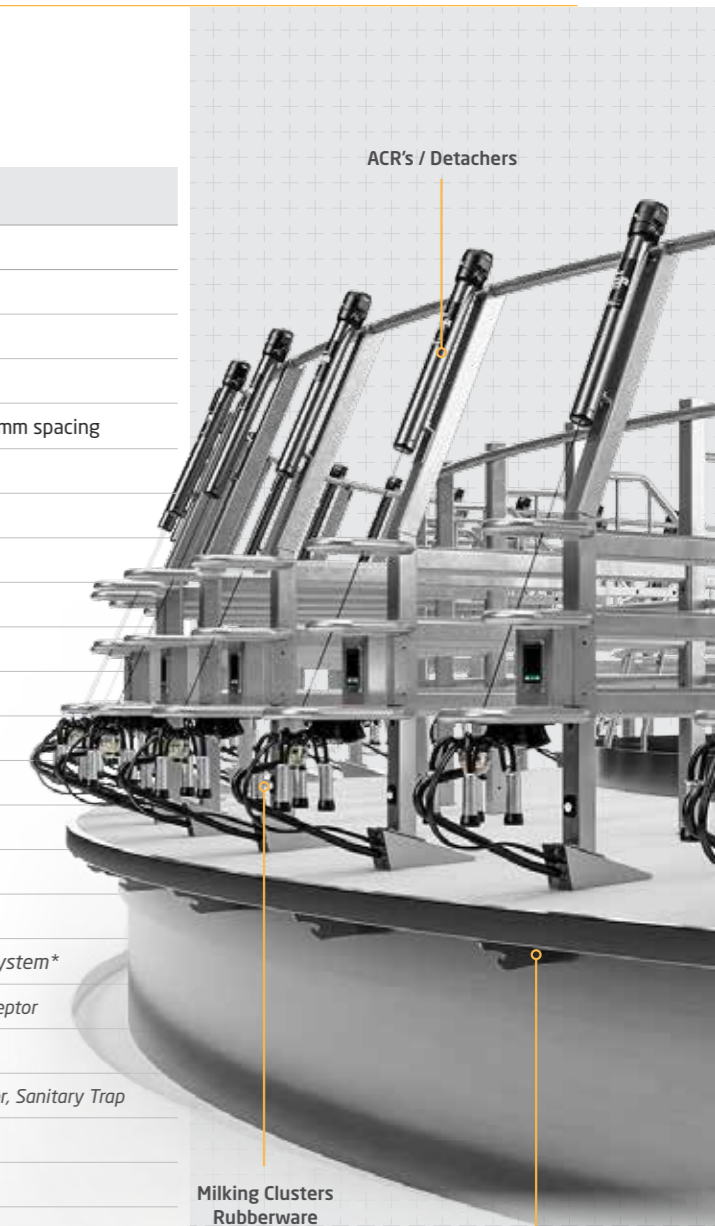

ACR's / Detachers

Milking Clusters Rubberware

Heavy Duty Sub Frame



Heavy Duty Galvanised or Stainless Steel Stallwork

100mm Reinforced Concrete Deck

* Some specifications may change depending on regional requirements

* Also available as a 9500s which has Stainless Steel stallwork

CENTRUS COMPOSITE MILKING SYSTEMS

Hard-working milking performance, that won't let you down.



CONSTRUCTED FOR PERFORMANCE, RELIABILITY AND LONGEVITY

Your farm demands hard-working performance, so the Centrus Composite Rotary Milking System rotary works hard for you.

Centrus is a groundbreaking system that has been designed to provide the ultimate in performance and reliability - allowing both family and commercial farmers to run more productive, cost-efficient and profitable operations.

Constructed to be structurally stronger, lighter and longer-lasting, Centrus will withstand the harshest of milking environments for generations to come.

Trusted by farmers around the world, the award-winning Centrus Composite Rotary Milking System is the result of over three decades of knowledge and experience, a passion for innovation and excellence - and partnerships with farmers.

Better for farmers: The Centrus Composite Rotary Milking System is user-friendly and delivers maximum milking efficiency so you can milk more efficiently and profitably. Centrus is ergonomically designed to improve performance and provide a quiet, comfortable and enjoyable milking environment.

Better for Cows: The Centrus Composite Rotary Milking System has been designed to provide an ergonomically correct milking environment for cows, and a stress-free milking environment for all herd sizes. Specially formulated soft and comfortable rubber mats enhance cow comfort and protects their hooves.



Heralded as the most significant evolution in rotary platform design in 50 years, our high-performance composite technology is structurally superior to concrete, chemically resistant, and more capable in any milking application - as well as being extremely quiet, lightweight, durable and easy to clean. With correct care and maintenance, the platforms will remain like new for their entire life - with no pitting or cracking with exposure to effluent and harsh chemicals.



Platform Structural & Chemical Resistance 5 Year Deck Guarantee

The Centrus system's multi-layer fiberglass composite construction makes it structurally superior to concrete platforms, and provides superior resistance to harmful chemicals, acids and manure - and comes with a 5 Year Platform Structural & Chemical Resistance Guarantee.



Less weight, less maintenance on running gear

The Centrus system's lightweight composite panel construction provides a 20 ton weight reduction on a typical 50 point concrete deck rotary - reducing the load on the roller assemblies and drives by approximately 33% to improve the working load limits and reducing wear and tear.



A quieter, safer working environment

The Centrus system's platform construction incorporates resin-bonded fiberglass layers and encapsulated foam to provide a quieter working environment for the operators and cows. The system also incorporates specially formulated rubber mats to ensure cow comfort and slip-resistant footing, and providing a safer, quieter working environment.

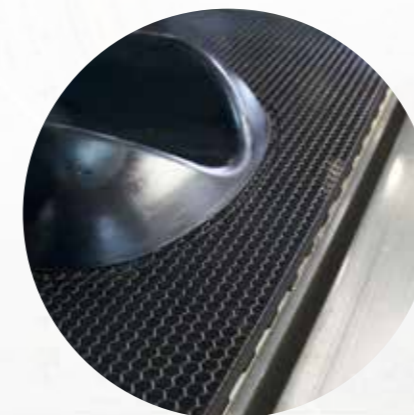

Built with extreme precision, for superior strength

The Centrus system is precision engineered to exacting standards and specifications in our state-of-the-art factory environment to ensure superior strength and a superior finish when compared with traditional concrete platforms - while also eliminating the potential for concrete inconsistencies of locally supplied aggregate mix.



CENTRUS 2500

Improve your milking performance and productivity, with the entry-level Centrus 2500 milking system.

PERFORMANCE, RELIABILITY AND PRODUCTIVITY

The Centrus 2500 is an entry-level composite rotary milking system that has been designed to provide the ultimate in performance and reliability - allowing you to run a more productive, cost-efficient and profitable operation.

Constructed to be structurally stronger, lighter and longer-lasting, the high-performance composite platform materials and nylon rollers ensure a lighter, more durable platform. Designed to provide a comfortable and enjoyable milking environment for the operator, the system also provides an ergonomically correct, quiet and stress-free milking environment for your cows.

The Centrus 2500 milking system is future-proofed, so it can be upgraded seamlessly with Waikato Milking Systems' dairy automation technology to increase your dairy automation journey when the time suits.

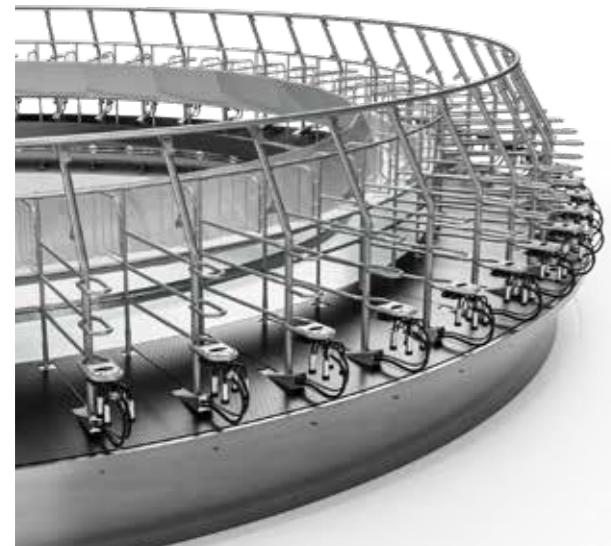

ADVANTAGES

The Centrus 2500 provides the entry-level model of next generation milking performance and productivity.



Better for farmers, better for cows.
The user-friendly system maximises efficiency and provides a quiet, comfortable and stress-free milking environment for the operator and cows.



Constructed for performance, reliability and longevity
The multi-layered laminated composite deck is up to 75% lighter, structurally superior, and more durable than traditional concrete or steel alternatives.



Upgradable for future-proofing
The system can be upgraded with dairy automation technology at a later date to further increase productivity and performance.



WHATS INCLUDED:

Platform:

- Rated Operating Duty per Day = 12 hrs
- Standard Stall width (875mm c/c outer rim)
- Standard Galvanised Stallwork
- Double Beam with nylon rollers at approx. 650mm spacing
- Lightweight, Heavy Duty Composite Deck
- Drive Units & Cups On Controls
- Heavy duty galvanised sub frame
- Extra wide 2.7m platform
- Rubber mats for cow comfort
- Automatic lubrication system
- Full circumference control and emergency stop ropes
- Entry crush switch
- Entry D-Gate Assembly
- Full circumference rump and kick rail
- Stainless steel dry edge

Milking System:

- Milking point: *Clusters, Rubberware, Pulsators*
- Milk Handling: *Milk Pump, Milk Filter, Plate Heat Exchanger*, Chilling System**
- Vacuum System: *Vacuum pump, Vacuum Controller, Rotary Swivel, Interceptor*
- CIP / Wash System: *Wash Tub, Jetters, Recirculation Lines*
- Stainless Steel Componentry: *Rolled milk, pulsator & wash lines, Receiver, Sanitary Trap*

** Some specifications may change depending on regional requirements*

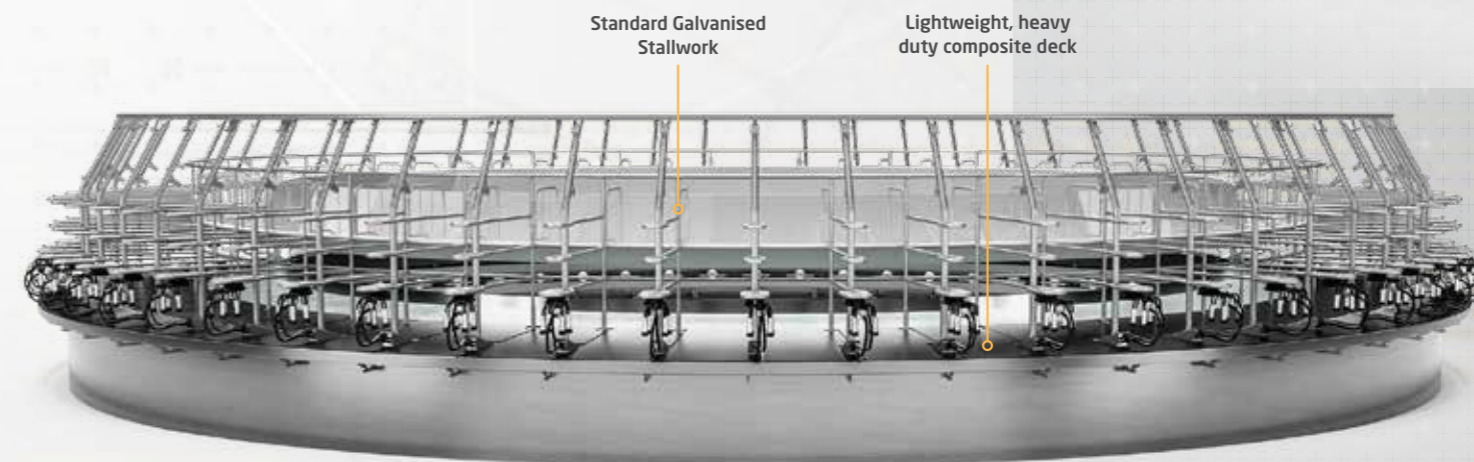
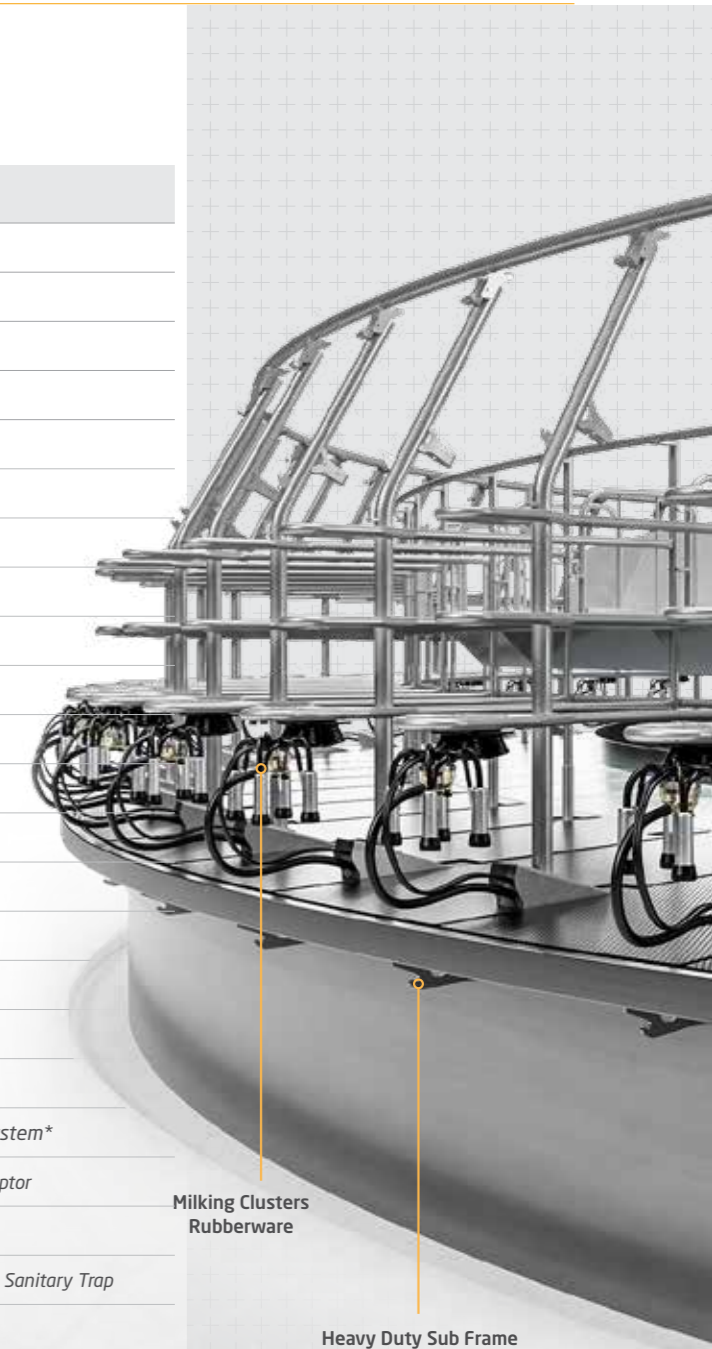

CENTRUS 5500

Increase your efficiency and productivity with the Centrus 5500 milking system's entry-level automation technology.

LABOUR-SAVING EFFICIENCY, IMPROVED PRODUCTIVITY.

Introducing the Centrus 5500 as an entry-level, automated composite rotary milking system, the 5500 has been designed to reduce your labour and improve your milking consistency, accuracy and efficiency.

The Centrus is a groundbreaking system that has been designed to provide the ultimate in performance and reliability - allowing commercial farmers to run more productive, cost-efficient and profitable operations. Constructed to be structurally stronger, lighter and longer-lasting, the high-performance composite platform materials, along with nylon rollers, will withstand the harshest of milking environments for generations to come.

By adding automation to your operation, to make the milking process quicker and easier for the operator, while cleanly, consistently and accurately milking out your herd, your labour costs will automatically reduce.

ADVANTAGES

The Centrus 5500 provides entry-level automation, offering greater milking efficiency, performance and productivity.



Better for farmers, better for cows.
The user-friendly system maximises efficiency and provides a quiet, comfortable and stress-free milking environment for the operator and cows.



Constructed for performance, reliability and longevity
The multi-layered laminated composite deck is up to 75% lighter, structurally superior, and more durable than traditional concrete or steel alternatives.



Increase efficiency and reduce labour costs
Labour-saving automatic cup removers offer a consistent milk out, while the User Display gives the operator real-time milking information and alerts.



WHATS INCLUDED:

Platform:

- Rated Operating Duty per Day = 12 hrs
- Standard Stall width (875mm c/c outer rim)
- Standard Galvanised Stallwork
- Double Beam with nylon rollers at approx. 650mm spacing
- Lightweight, Heavy Duty Composite Deck
- Drive Units & Cups On Controls
- Heavy duty galvanised sub frame
- Extra wide 2.7m platform
- Rubber mats for cow comfort
- Automatic lubrication system
- Full circumference control and emergency stop ropes
- Entry crush switch
- Entry D-Gate Assembly
- Full circumference rump and kick rail
- Stainless steel dry edge

Milking System:

- Milking point: *Clusters, Rubberware, Pulsators*
- Milk Handling: *Milk Pump, Milk Filter, Plate Heat Exchanger*, Chilling System**
- Vacuum System: *Vacuum pump, Vacuum Controller, Rotary Swivel, Interceptor*
- CIP / Wash System: *Wash Tub, Jetters, Recirculation Lines*
- Stainless Steel Componentry: *Rolled milk, pulsator & wash lines, Receiver, Sanitary Trap*

Dairy + Animal Management:

- ACR's / Detachers

** Some specifications may change depending on regional requirements*

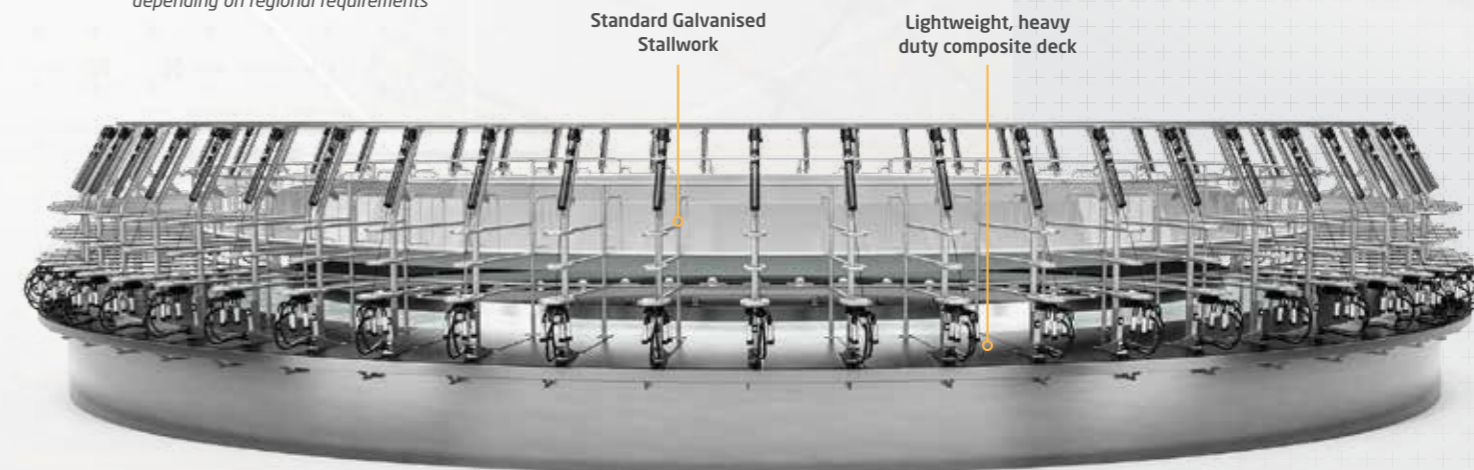
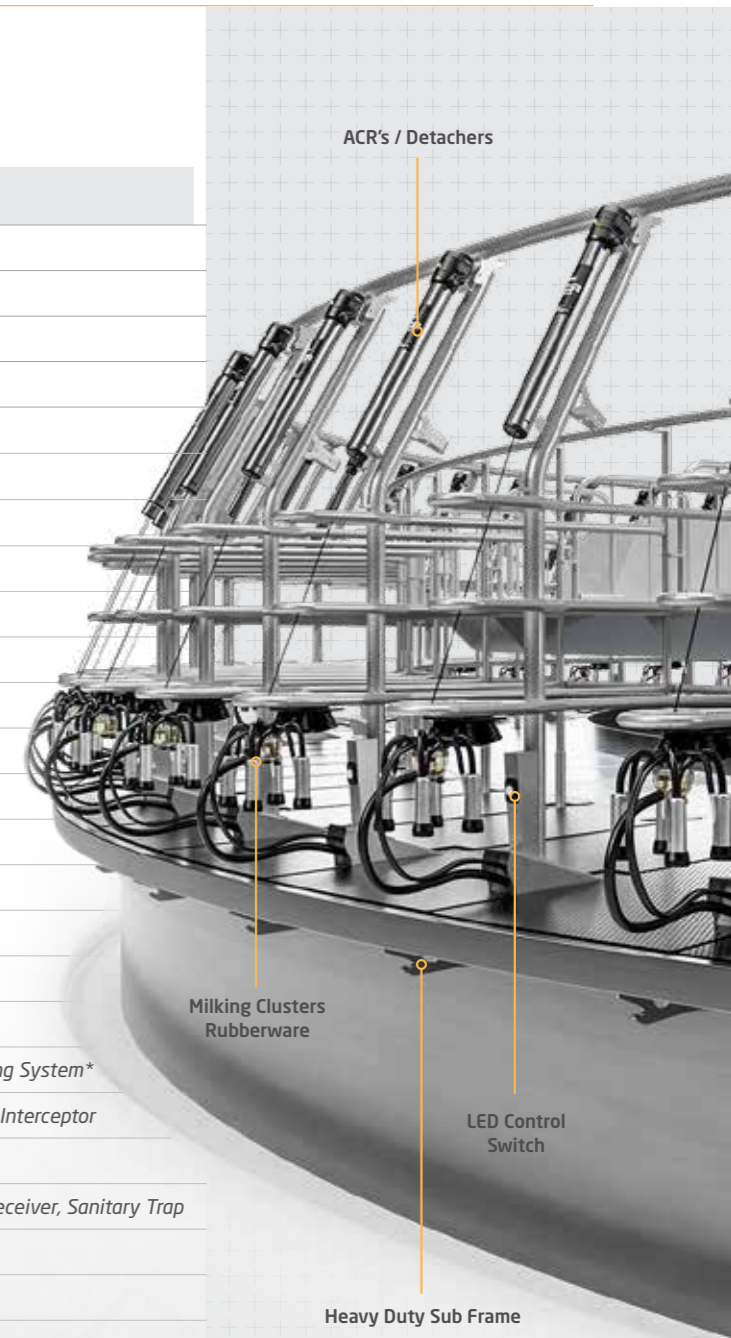

CENTRUS 9500

Maximise your efficiency and productivity 24/7, with the Centrus 9500 milking system's full-suite of automation technology.

MAXIMISE YOUR MILKING EFFICIENCY & PRODUCTIVITY

The Centrus 9500 provides a full-suite of automation technology including automatic cup removers, automatic udder health monitoring and pre-milking stimulation, milk yield to measure and record milk volumes, run via a dairy management system.

Designed to be structurally stronger, lighter and longer-lasting, the Centrus 9500 platform is constructed from high-performance composite materials and features nylon rollers, to ensure a more durable and longer-lasting system. The Centrus 9500 offers strong and durable, extra comfort width, heavy duty stallwork which is ideal for parlours with larger stock, providing the strength and durability required for 24/7 milking.

Providing a more comfortable overall milking environment for the operator, and an ergonomically correct, quiet and stress-free milking environment for cows, it's a system of choice for commercial milking operations.

ADVANTAGES

The Centrus 9500 provides a full-suite of automation and greater milking efficiency, performance and productivity.



Unmatched performance and longevity
The multi-layered laminated composite deck is up to 75% lighter, structurally superior, and more durable than traditional concrete or steel alternatives.



Maximise your milking data collection and communication
A full automation suite gives real-time data along with animal health and performance monitoring.



Strong & durable extra comfort width stallwork
Designed for use in parlours with larger stock, providing a level of strength and durability for 24/7 milking.



WHATS INCLUDED:

Platform:

- Rated Operating Duty per Day = 24 hrs
- Extra Comfort Bail Width (980mm c/c outer rim)
- Heavy Duty Galvanised Stallwork
- Double Beam with nylon rollers to suit 24/7 systems, at approx. 450mm spacing
- Lightweight, Heavy Duty Composite Deck
- Drive Units & Cups On Controls
- Heavy duty galvanised sub frame
- Extra wide 2.7m platform
- Rubber mats for cow comfort
- Automatic lubrication system
- Full circumference control and emergency stop ropes
- Entry crush switch
- Entry D-Gate Assembly
- Full circumference rump and kick rail
- Stainless steel dry edge

Milking System:

- Milking point: *Clusters, Rubberware, Pulsators*
- Milk Handling: *Milk Pump, Milk Filter, Plate Heat Exchanger*, Chilling System**
- Vacuum System: *Vacuum pump, Vacuum Controller, Rotary Swivel, Interceptor*
- CIP / Wash System: *Wash Tub, Jetters, Recirculation Lines*
- Stainless Steel Componentry: *Rolled milk, pulsator & wash lines, Receiver, Sanitary Trap*

Dairy + Animal Management:

- ACR's / Detachers
- Milking Point User Display
- Mastitis and Udder Health Detection
- Milk Metering
- Dairy Management System

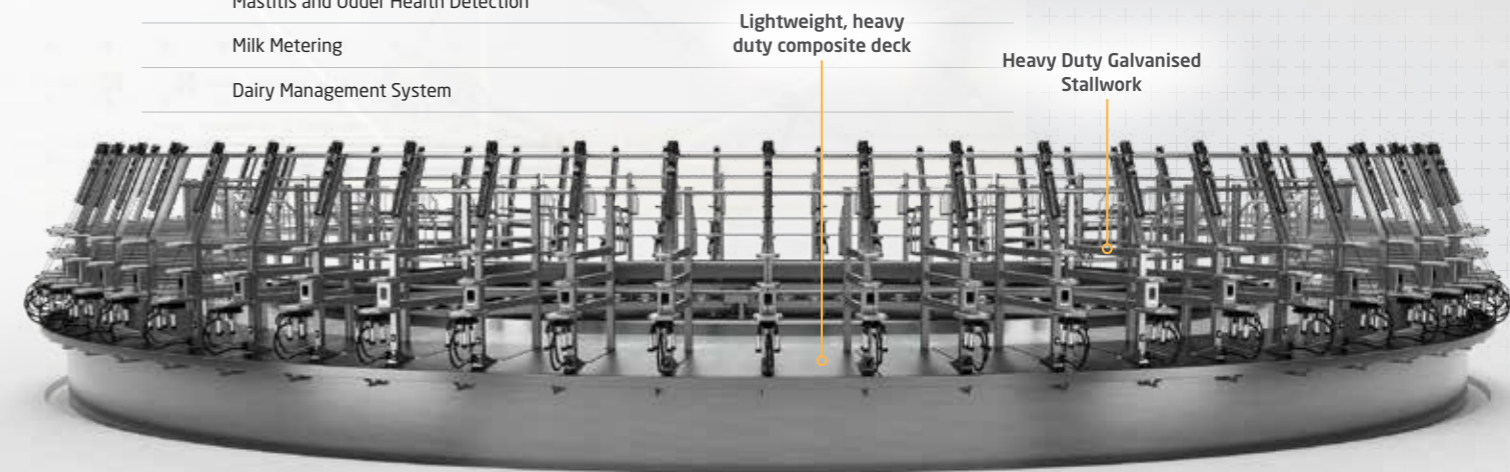
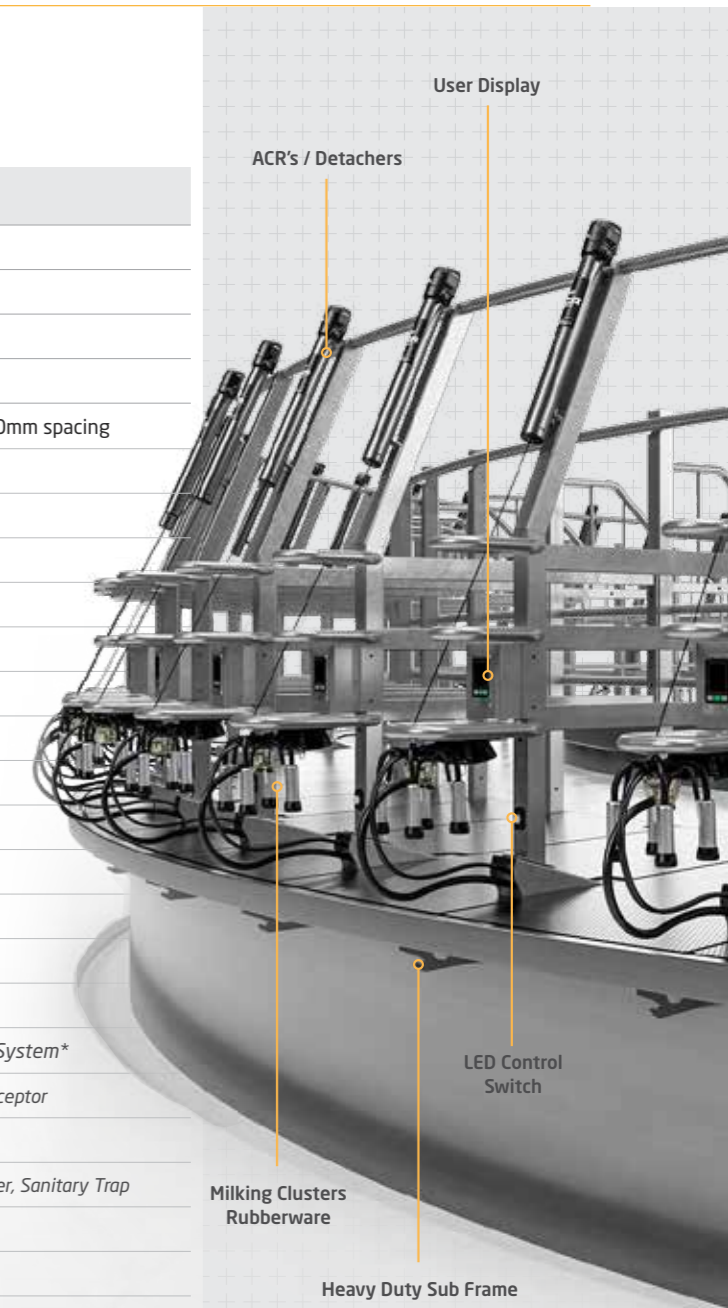

* Some specifications may change depending on regional requirements

CENTRUS 9500s

Maximise your industrial-level efficiency 24/7, with the Centrus 9500s milking system's full-suite of automation technology and industrial rollers.

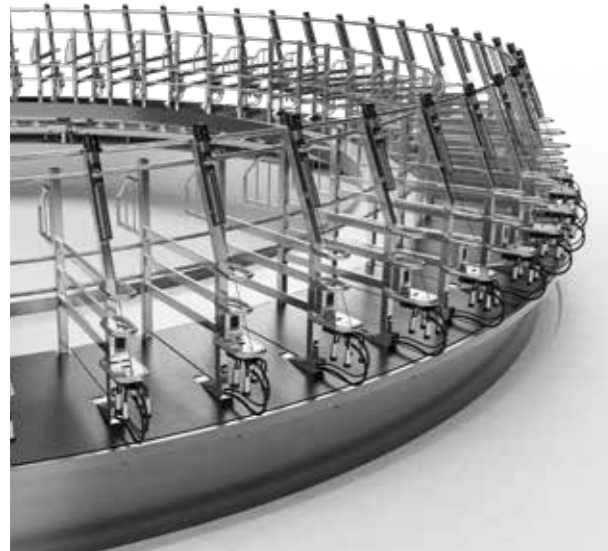

INDUSTRIAL ROLLERS, STAINLESS STALLING, INDUSTRIAL-LEVEL EFFICIENCY

The Centrus 9500s provides a fully automated, ground-breaking system that is designed to never stop turning, so you can run a more productive, cost-efficient and profitable operation.

Constructed from high-performance composite materials, the Centrus 9500s features industrial rollers which reduce the point loading on 24/7 operations. The stainless steel heavy duty stallwork is resistant to chemical spray and effluent and is easier to clean and maintain. The Centrus 9500s is designed to be structurally stronger, lighter and longer-lasting.

The system has been designed to ensure a comfortable and enjoyable milking environment for the operator and is ergonomically correct for cows, providing a quiet and stress-free milking for all.

ADVANTAGES

The Centrus 9500s provides a full-suite of automation and greater milking efficiency, performance and productivity.



Unmatched performance and longevity
The multi-layered laminated composite deck is up to 75% lighter, structurally superior, and more durable than traditional concrete or steel alternatives.



Automated for maximum efficiency
A full automation suite gives real-time data along with animal health and performance monitoring.



Strong, durable stainless steel stallwork
Resistant to chemical spray and effluent, stainless steel stallwork is low maintenance, easy-to-clean and maintain.



WHATS INCLUDED:

Platform:

- Rated Operating Duty per Day = 24 hrs
- Extra Comfort Bail Width (980mm c/c outer rim)
- Heavy duty Stainless Steel Stallwork
- Double Beam with nylon rollers to suit 24/7 systems, at approx. 450mm spacing
- Lightweight, Heavy Duty Composite Deck
- Drive Units & Cups On Controls
- Heavy duty galvanised sub frame
- Extra wide 2.7m platform
- Rubber mats for cow comfort
- Automatic lubrication system
- Full circumference control and emergency stop ropes
- Entry crush switch
- Entry D-Gate Assembly
- Full circumference rump and kick rail
- Stainless steel dry edge

Milking System:

- Milking point: *Clusters, Rubberware, Pulsators*
- Milk Handling: *Milk Pump, Milk Filter, Plate Heat Exchanger*, Chilling System**
- Vacuum System: *Vacuum pump, Vacuum Controller, Rotary Swivel, Interceptor*
- CIP / Wash System: *Wash Tub, Jetters, Recirculation Lines*
- Stainless Steel Componentry: *Rolled milk, pulsator & wash lines, Receiver, Sanitary Trap*

Dairy + Animal Management:

- ACR's / Detachers
- Milking Point User Display
- Mastitis and Udder Health Detection
- Milk Metering
- Dairy Management System

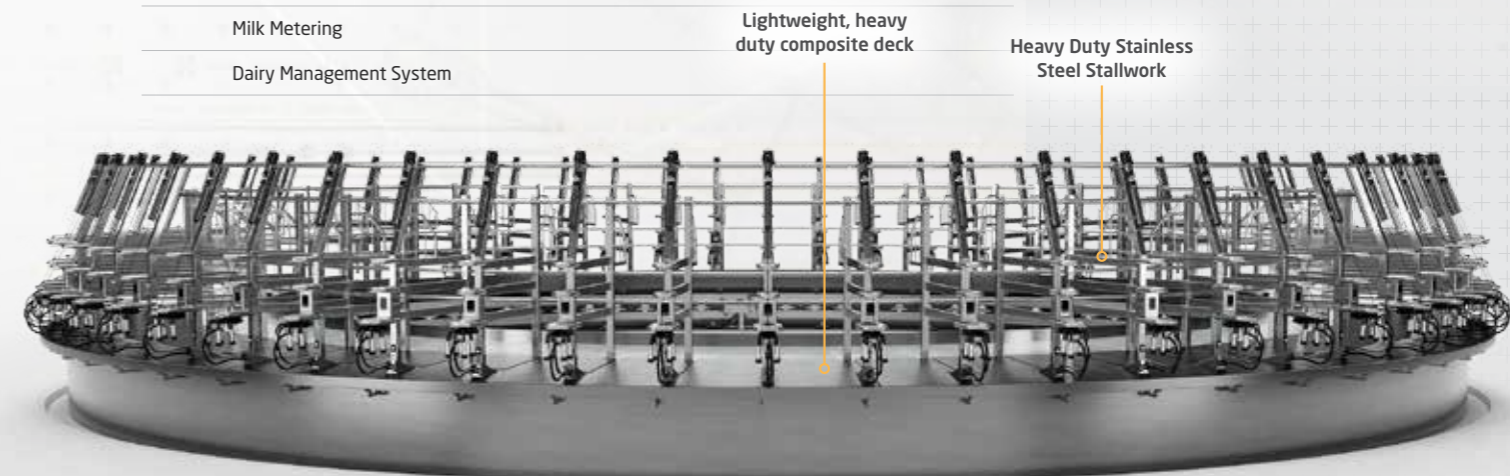
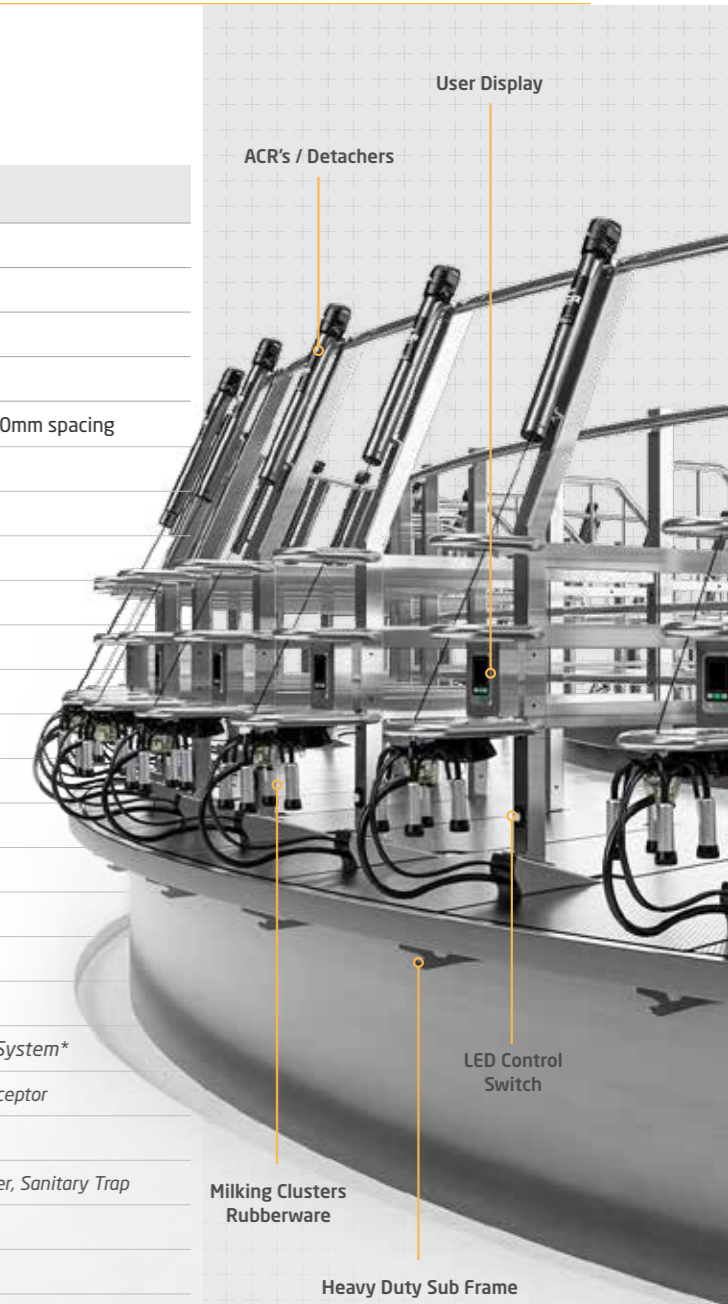

* Some specifications may change depending on regional requirements

VELOCITY COMPOSITE MILKING SYSTEMS

Advanced milking performance, that is second to none.

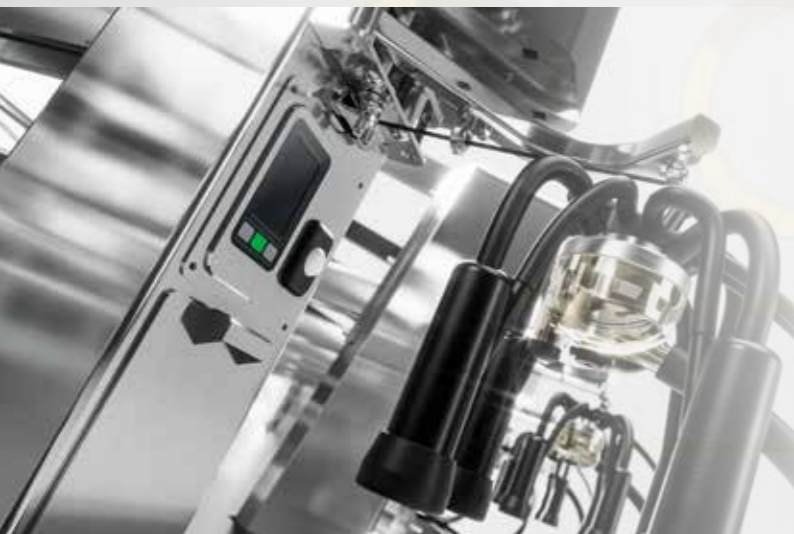

DESIGNED FOR UNSTOPPABLE PERFORMANCE AND LONGEVITY

Your farm never stops, so the Velocity Composite Rotary Milking System rotary doesn't either.

Unlike other rotaries, Velocity is a state-of-the-art system that has been designed to withstand the demands of the busiest commercial farmers, to run more productive, efficient and profitable operations 24/7. Constructed to be structurally stronger, lighter and longer-lasting, Velocity will withstand the harshest of milking environments for generations to come.

The Velocity system allows you to milk large numbers of cows easily. The low profile milking cabinet is designed to improve performance and milking speed, enabling the animals to flow on and off the platform with less effort and at a higher speed. Velocity features a simple touch-button start, lightweight clusters with a cluster arm that guides the cluster into milking position and swings out of the cows way on detachment as well as smart milking technologies.

Better for farmers: The Velocity Composite Rotary Milking System with its fully integrated milking cabinet, works seamlessly together to reduce labour and improve performance, while offering a quiet, comfortable and enjoyable milking environment.

Better for Cows: Designed to provide an ergonomically correct milking environment for cows, the smooth edges on the stainless steel cabinet ensure safe cow flow. The specially formulated soft and comfortable replaceable rubber mats enhance cow comfort and protects their hooves.

Heralded as the most significant evolution in rotary platform design in 50 years, our high-performance composite technology is structurally superior to concrete, chemically resistant, and more capable in any milking application - as well as being extremely quiet, lightweight, durable and easy to clean. With correct care and maintenance, the platforms will remain like new for their entire life - with no pitting or cracking with exposure to effluent and harsh chemicals.



Robust Stainless Steel Cabinet with fully integrated milking equipment

The Cabinet contains the pneumatic detacher, automation display, multi-function touch-button and CIP unit.



Clever cluster arm and pneumatic detachers with easy adjustment

The cluster arm guides the cluster into the correct milking position and swings out of the way on detachment, for the cow to exit the stall area. The retraction cord can be adjusted (lengthened/shortened) from the front of the cabinet with a simple tool. This makes maintenance and fine tuning easy.



Easy washup for the Cabinet, stall and the milking equipment

The smooth outer stainless steel cabinet is easy to clean. The cluster washer folds out for attachment to the teatcups and retracts for milking. A secondary cover reduces water ingress while the CIP is in use.



Platform Structural & Chemical Resistance 5 Year Deck Guarantee

The Velocity system's multi-layer fiberglass composite construction makes it structurally superior to concrete platforms, and provides superior resistance to harmful chemicals, acids and manure - and comes with a 5 year platform structural and chemical resistance guarantee.



VELOCITY 9500

Increase your milking speed and enjoy a stress-free milking environment 24/7 with the Velocity 9500 Composite Rotary Milking System.

HIGH-VELOCITY MILKING FOR CONTINUOUS HIGH THROUGH-PUT

Living up to its name, the Velocity Composite Rotary Milking System has been designed to increase your milking speed, productivity and performance while enjoying a stress-free milking environment.

The innovative system features fully-integrated, low profile cabinets, which house the pneumatic detacher, display automation, a multi-function control switch and cluster washer. The cabinet assists in separating cows - enabling the animals to flow on and flow off the platform with less effort and at a higher speed.

The stainless steel heavy duty stallwork is resistant to chemical spray and effluent and is easier to clean and maintain, meaning the system will handle the harshest of milking environments and stand the test of time.

Also available in:

5500 Heavy duty galvanised stallwork

ADVANTAGES

The Velocity 9500 increases your milking speed and provides a stress-free milking environment 24/7.



Stress-free, high-velocity milking
The robust, low-profile cabinets allow cows to enter and exit the stalls easier and faster to create a more enjoyable and efficient working environment.



Structurally superior
A lighter and stronger construction makes it superior to concrete alternatives.



Easily adjusted cluster arm
The cluster arm guides the cluster into the correct milking position and swings out of the way on detachment.



WHATS INCLUDED:

Platform:

- Rated Operating Duty per Day = 24 hrs
- Extra Comfort Bail Width (980mm c/c outer rim) * varies above 80 stalls
- Low profile stainless steel cabinet
- Heavy duty Stainless Steel Stallwork
- Double Beam with 140 dia. nylon rollers to suit 24/7 systems, at approx. 450mm spacing (190 dia for >80 stalls)
- Stainless Steel Outer Dry Edge
- Lightweight, Heavy Duty Composite Deck
- Heavy duty galvanised sub frame
- Extra wide 2.7m platform
- Drive Units & User Controls
- Rubber mats for cow comfort
- Automatic lubrication system
- Full circumference control and emergency stop ropes
- Entry crush switch
- Entry D-Gate Assembly
- Full circumference rump and kick rail
- Stainless Steel Dry Edge

Milking System:

- Milking point: *Clusters, Rubberware, Pulsators*
- Milk Handling: *Milk Pump, Milk Filter, Plate Heat Exchanger*, Chilling System**
- Vacuum System: *Vacuum pump, Vacuum Controller, Rotary Swivel, Interceptor*
- CIP / Wash System: *Wash Tub, Jetters, Recirculation Lines*
- Stainless Steel Componentry: *Rolled milk, pulsator & milk lines, Receiver, Sanitary Trap*

Dairy + Animal Management:

- Pneumatically operated ACR's / Detachers
- Milking Point User Display
- Mastitis and Udder Health Detection
- Milk Metering
- Dairy Management System

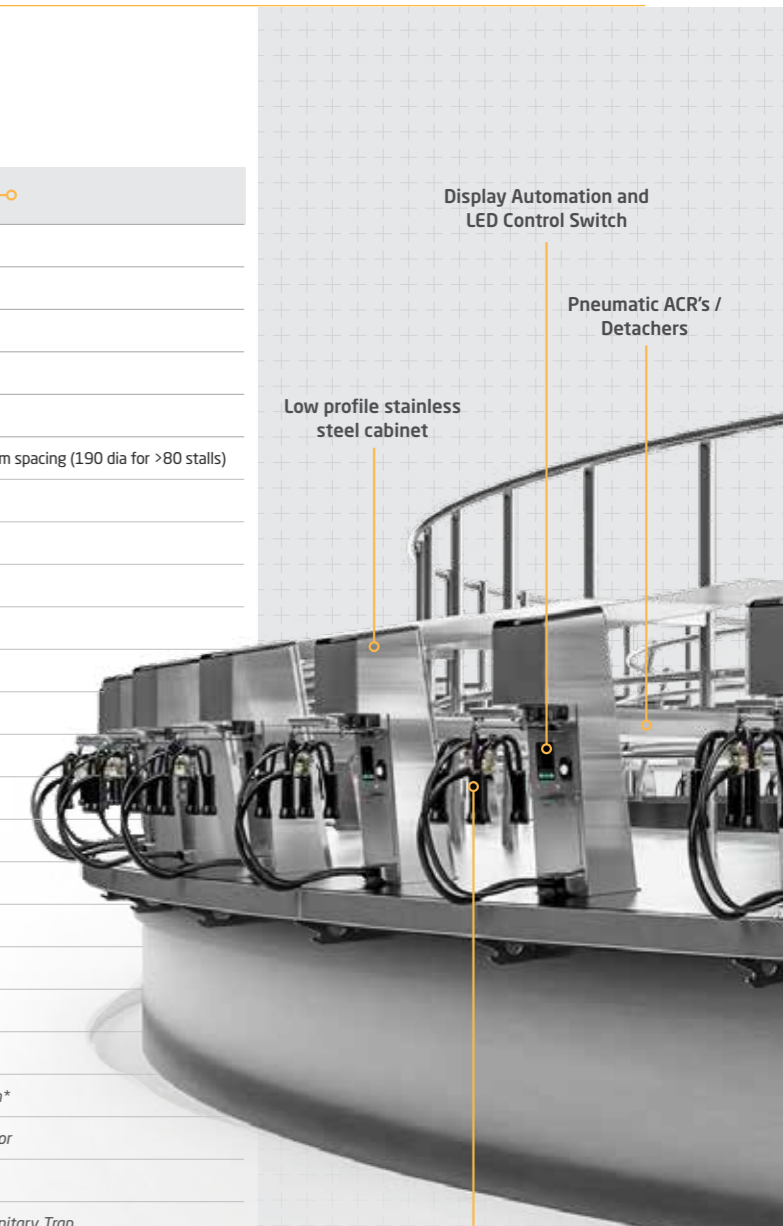

Display Automation and LED Control Switch

Pneumatic ACR's / Detachers

Low profile stainless steel cabinet

High Performance Milking Clusters

Heavy Duty Stainless Steel Stallwork

Lightweight, heavy duty composite deck

Low profile stainless steel cabinet



* Some specifications may change depending on regional requirements

SYSTEMS COMPARISON CHART

Below is a table that indicates the range of specifications across all our systems, so you can compare and see what best fits your requirements.

	ORBIT CONCRETE				CENTRUS COMPOSITE				VELOCITY	
	2500	5500	9500	9500s	2500	5500	9500	9500s	5500	9500
Rated operating duty per day	12 hrs / day	12 hrs / day	24 hrs / day	24 hrs / day	12 hrs / day	12 hrs / day	24 hrs / day	24 hrs / day	24 hrs / day	24 hrs / day
Standard Stall Width (875mm c/c outer rim)	■	■			■	■				
Extra Comfort Bail Width (980mm c/c outer rim)			■	■			■	■	■	■
Standard Galvanised Stallwork	■	■			■	■				
Heavy Duty Galvanised Stallwork			■				■		■	
Heavy Duty Stainless Steel Stallwork				■				■		■
Low Profile Stainless Steel Cabinet									■	■
Double Beam, nylon rollers approx. 650mm spacing	■	■			■	■			■	■
Double Beam, nylon rollers 24/7 systems, approx. 450mm spacing			■	■			■	■	■	■
100mm Concrete deck	■	■	■	■						
Lightweight, Heavy Duty Composite Deck					■	■	■	■	■	■
Drive Units & Cups On Controls	■	■	■	■	■	■	■	■	■	■
Heavy duty galvanised sub frame	■	■	■	■	■	■	■	■	■	■
Extra wide 2.7m platform	■	■	■	■	■	■	■	■	■	■
Rubber Mats for cow comfort					■	■	■	■	■	■
Automatic lubrication system	■	■	■	■	■	■	■	■	■	■
Full circumference control and emergency stop ropes	■	■	■	■	■	■	■	■	■	■
Entry Crush Switch	■	■	■	■	■	■	■	■	■	■
Entry D-Gate Assembly	■	■	■	■	■	■	■	■	■	■
Full circumference Rump and Kick Rail	■	■	■	■	■	■	■	■	■	■
Stainless Steel Dry Edge					■	■	■	■	■	■
ACR's / Detachers		■	■	■		■	■	■	■	■
Milking Point User Display			■	■			■	■	■	■
Mastitis and Udder Health Detection			■	■			■	■	■	■
Milk Metering			■	■			■	■	■	■
Dairy Management System			■	■			■	■	■	■



LABOUR SAVING AND PRODUCTIVITY

Reduce your labour costs and maximise your productivity with our range of state-of-the-art automated technologies.

ECR-S ACRs / DETACHERS

Reduce your labour and improve your milking consistency, accuracy and efficiency.



AUTOMATICALLY REMOVE CUPS, AND REDUCE YOUR LABOUR COSTS

The ECR-S is a robust, easy to use and dependable ACR / Detacher that reduces labour, while cleanly, consistently and accurately milking out your herd.

The ECR-S, with an auto-start feature, has been designed to make the milking process quicker and easier for the operator, while accurate flow sensing provides peace of mind that the herd is being milked out correctly every time.

Suitable for all milking machines, the milking parameters can be easily adjusted to suit your farm's requirements via the ECR-S Controller. This ensures all ACR / Detachers are set the same - and milk each animal the same.

In rotary dairies ECR-S can control the Cow Restraints to retain cows for alerts or longer milkings. ECR-S can also control the SmartSPRAY system to teat spray cows at the end of milking, to further reduce labour and improve udder and animal health.



ControlSWITCH works with ECR-S, giving highly visible alerts for operator feedback on cow alerts and machine status

What's Included:

- **ECR-S ram:** Cup remover cylinder and integrated control circuit board. Accurate and reliable milking of your animals
- **EZY-Start as standard:** ECR is started by simply lifting the cluster
- **SmartCONTROL:** Centralised settings and parameter changes. Quickly and easily adjust your milking regime.
- **ControlSWITCH:** solid state switch which provides visible alerts to the operator



ADVANTAGES

ECR-S allows you to milk out your herd consistently and accurately, while reducing labour.



Centralised control

Global communication from the ECR-S Controller allows the adjustment of milking parameters for all detachers from one place.



Reduces effort and fatigue

The Ezy Pull-Down valve reduces operator fatigue by reducing the effort needed to attach the cluster.



Gentle on the cow and stallwork

The retraction speed adjustment allows for a gentle disconnect from the udder and stops the cluster crashing into stallwork.



Indicates the status of the ECR

ECR PLUS ACRs / DETACHERS

Maximise your milking automation and efficiency, and make the most informed management decisions.

AUTOMATE YOUR MILKING, AND FUTURE-PROOF YOUR MILKING SYSTEMS

The ECR Plus combines the most advanced ACR / Detacher functions with the collection and communication of milking information configured to suit your farms individual requirements.

Designed to be the heart of your milking automation, ECR Plus allows you to add other milking automation devices using our Plug 'n' Play technology to collect important real-time information from your herd. These can include yield, flow rates, milking time, and the ability to control pulsation and measure milk conductivity for udder health issues and display alerts.

The ECR Plus system is designed to integrate with the DairyHQ™ Dairy Management software which enables powerful features including staff alerts for withholding cows as they enter the machine, and identifying abnormal milkings as they occur. The milking data generated by the ECR Plus system and connected devices can also be used within the DairyHQ™ Dairy Management software to make timely and informed decisions for your milking herd.

What's Included:

- **ECR-PLUS ram:** Cup remover cylinder and integrated control circuit board. Accurate and reliable milking of your animals
- **EZY-Start as standard:** ECR Plus is started by simply lifting the cluster
- **DairyHQ™ Control:** Allows for settings and parameter changes from your phone or PC. Can be upgraded to control all aspects of your parlour including Sorting and ID.
- **ControlSWITCH:** touch-activated switch which gives visible alerts to the operator



ControlSWITCH works with ECR-S, giving highly visible alerts for operator feedback on cow alerts and machine status

DairyHQ™ Dairy Management System



ADVANTAGES

ECR Plus maximises milking automation and efficiency, and the collection and communication of your milking information.



Feature-packed automation technology

Includes all features of the ECR-S system plus Claw Drop, Pre-Spray and Fixed Point Take Off



Powerful data management and communication

Seamless integration with our DairyHQ™ Dairy Management System allows for milking alarms and much more



Future-proof your milking system

True Plug 'n' Play technology can be configured to suit your milking requirements today, while allowing for future expansion by simply plugging in new technology



Indicates the status of the ECR



USER DISPLAY

Monitor each animal's status in real-time, and detect issues immediately.



REAL-TIME MILKING INFORMATION AND ALERTS, ON DISPLAY.

The User Display provides the operator with the exact status of each animal, and includes any alerts that may have occurred.

Mounted on the stall and out of the way of your milking operation, the User Display features a backlit LCD display with large characters making the information and data quick and easy to read.

Different coloured flashing LEDs illuminate the User Display when there is an alert - making it easy for the operator to detect an issue and take appropriate action quickly and effectively, or show when in wash mode.

With a robust stainless steel housing, the User Display is protected from day-to-day impacts and the parlour environment.

ADVANTAGES

The User Display allows you to monitor real-time milking information on your animals.



Real-time information and alerts
Displays real-time information including Current Yield & Flow Rate, Milking Time, Animal ID and Operator Alerts



Animal drafting features
Animals can be drafted from the display via the buttons.



Retain cows in stall
Manual retain cow in stall with optional Cow Restraint features.

COW RESTRAINTS COW RETENTION

Restrain your cows automatically and save time and money.

MAKE COW RESTRAINT AND MANAGEMENT EASIER, AUTOMATICALLY



Cow Restraints are automatically lowered and raised, when used in conjunction with ECR-S or ECR Plus cup removers, making it easier to manage animals on your rotary platform.

Activated by a hydraulic ram, the Cow Restraints drop automatically after cupping, to keep the cow in the stall, and lift when the cow finishes milking allowing her to exit the platform.

If the cups are kicked off, the restraint stays down so the cow is presented back to the operator for inspection.

Waikato Cow Restraints are made from flexible but durable plastic and can easily be retrofitted into existing farm dairies.

ADVANTAGES

Cow Restraints save on labour by allowing you to restrain your cows automatically.



Save time and money
Saves labour by eliminating the need for an operator at Cups Off



Optional lower setting only
Can be set to only lower the Cow Restraints if needed (alarms or still milking at bridge)



Customisable alarms
Select which alarms will retain an animal to suit your farm's milking procedures



320 STANDARD MILKING CLUSTER

An entry-level milking cluster designed to optimise the milk harvesting process.



OPTIMISE YOUR MILK HARVESTING PROCESS WITH AN INDUSTRY PROVEN CLUSTER

The 320 Standard Cluster is an entry-level cluster that has been well proven in the market place for many years.

The Waikato Milking Systems' Standard Milking Cluster provides even milk extraction from each quarter for faster, more efficient milking.

Featuring large bore inlets and outlets to improve milk flow and evacuation, while ensuring a stable milking environment. The robust design of the Standard Milking Cluster optimises the milk harvesting process with a lower entry price.

ADVANTAGES

The Standard Milking Cluster provides optimised milk extraction.



Optimise your milk harvesting
Achieving even extraction from each quarter, faster, this ensures a more efficient milking.



High performance cluster
With stainless steel tops, suitable for large bore liners, the 320 Standard Milking Cluster, gives you the performance you need



Five year Claw warranty
The 320 Standard Milking Cluster offers a 5 year warranty on the Claw bowl, giving you peace of mind.



320 HIGH PERFORMANCE CLUSTER

Ergonomically designed for an all round better, more efficient milking.

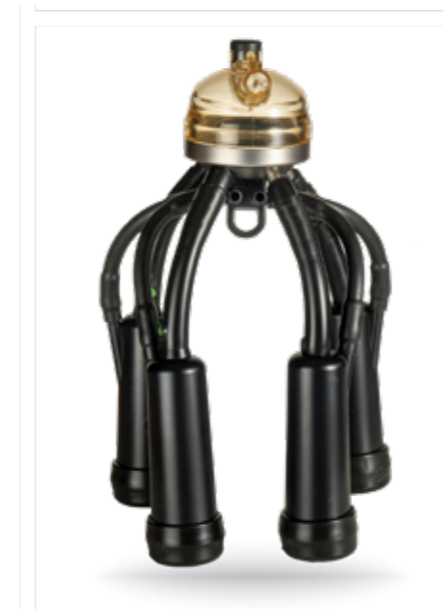

ERGONOMICALLY DESIGNED FOR OPTIMUM FIT AND ANIMAL COMFORT

The 320HP Milking Cluster has been designed to provide a reduced cluster weight, minimising operator fatigue. Teat condition and udder health is improved for teats of all sizes.

The perfect fit of the vented liner provides you with unsurpassed milk extraction and even milk flow from all quarters. The vented liner improves vacuum stability at high milk flow rates.

The unique design of the claw conforms to the latest cow genetics, with narrow rear inlets to improve cluster alignment and milk flow through the teat canal and high-capacity 5/8" and 3/4" outlet versions to effectively and efficiently move milk away from the teat end during liner closure. With its robust, lightweight and ergonomic design, the 320 High Performance Milking Cluster allows the vacuum, pulsation, liner, and the milking unit to work together to optimise the milk harvesting process.

ADVANTAGES

The 320 High Performance Milking Cluster allows you to achieve the fastest milking speed possible, for maximum efficiency.



Ergonomically designed
Provides the optimum fit for cows of varying udder shapes and sizes, and easy handling for operators of all hand-sizes.



Reduces repetitive strain injuries
The 320HP Milking Cluster is super lightweight, significantly reducing the operator's risk of repetitive strain injuries (RSI)



25% lighter cluster design
Weights only 1.3kg (2.86 lb) with a 320ml (10.82fl.oz) claw bowl and comes with a 5 year unconditional bowl warranty



SMARTD-TECT UDDER HEALTH DETECTION

Reduce your labour and increase your productivity with SmartD-TECTs automation technology.

REDUCE LABOUR. INCREASE PRODUCTIVITY

SmartD-TECT performs a health analysis of each quarter of the udder by automating your pre-milking stimulation and udder health monitoring without adding additional tasks for the operator.

SmartD-TECT allows you to make data-driven decisions for your herd's health reducing the chance of any loss in productivity. The pulsator milks each quarter separately to measure the conductivity of each teat during the pre-milking phase. Individual quarter conductivity allows SmartD-TECT to eliminate issues with dilution between quarters to provide highly accurate alerts for potential health problems. If any quarters are abnormal, an alert is issued up to four days before visual signs appear, providing the opportunity for early treatment intervention. The pre-milking pulsation for quarter testing also promotes a natural let down response from the cows, eliminating precious time normally spent manually stimulating teats to trigger milk flow. By having the same milking routine each time, cows let their milk down faster, more consistently and at a higher average flow rate. By removing the variabilities of operators, SmartD-TECT provides consistency in performance and productivity advantages that no other conventional milking system offers.

What's Included:

- **SmartD-TECT Pulsator:** Controls individual pulsation signals to the cluster allowing each quarter to be milked separately at the start of milking.
- **SmartD-TECT Sensor:** are attached to the milk line at every cluster to measure the conductivity of the milk from each cow. The results are sent to the pulsator for interpretation.
- **SmartD-TECT Controller:** Is a touchscreen interface that controls SmartD-TECT's sensitivity settings.



ADVANTAGES

SmartD-TECT provides peace of mind for a consistent milking routine and the automated detection of problematic animals and potential udder health issues, reducing treatment time and cost.



Udder Health Monitoring

Identify the onset of mastitis up to four days before visual signs are evident to make decisions earlier.



Individual Quarter Testing

The pulsator milks each quarter separately and measures the conductivity of each for a more accurate alert.



Eliminate Forestripping

Automate your milking stimulation and prep routine to reduce labour and increase your productivity.

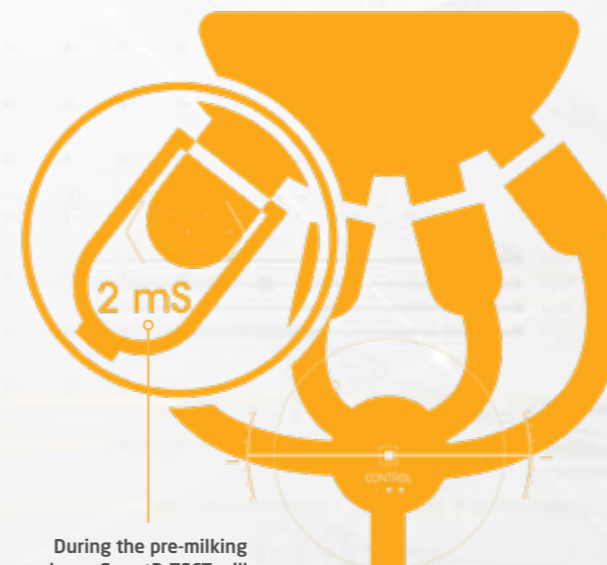

During the pre-milking phase, SmartD-TECT milks each quarter separately and measures the conductivity



SMARTSPRAY AUTOMATED TEAT SPRAYING

Automated teat spraying that reduces your labour and increases your efficiency.

MAXIMUM TEAT COVERAGE, WITH MINIMAL LABOUR

SmartSPRAY is an innovative automatic teat spray system designed specifically for rotary dairies, that replaces the need for manual teat spraying and teat dipping before and after milking.

With no operator input required during milking, SmartSPRAY greatly reduces labour while ensuring maximum coverage regardless of the cow's position in the bail. The spray nozzles on the bullets can be rotated to cater for a wide variety of cow sizes and different breeds. The bullets are easy to clean and made of durable material designed to withstand years of harsh treatment under the cows at milking time.

The SmartSPRAY system is controlled directly by Waikato ECR-S or ECR Plus cup removers. When combined with Waikato Milking Systems cup removers, SmartSPRAY can be set so it doesn't spray animals that are returning to the operator.

It's possible to fit the SmartSPRAY to other rotary systems using an interface to connect with other types of cup removers.

What's Included:

- **2 or 4 spray nozzles:** built into the Bullet leg spreader (per stall), 2 nozzles are standard, 4 are used for pre & post spraying
- **Electronic solenoid valve:** for accurate volume dispensing
- **On platform chemical storage vessel**
- **Off platform Chemical mixing vessel:** for safe and convenient premixing of spray
- **Pressure adjustable, air driven spray delivery pump:** to optimize spray delivery

ADVANTAGES

The SmartSPRAY system automates teat spraying to save time and labour.



Sprays every cow, every time
Reduces labour in the parlour while ensuring maximum coverage and optimum teat condition



Easier spraying, easier cupping
The spray system also acts as a leg spreader to make cupping easier



Pre-milking option
A pre-milking spray option is available (only with DairyHQ™ Dairy Management) which reduces labour



Bullet also works as a leg spreader to make cupping more effective



SMARTWASH AUTOMATED WASH SYSTEM

A pre-programmed wash controller to save on labour and increase your efficiency.



A COMPREHENSIVE AND AUTOMATIC WASH, AT THE TOUCH OF A BUTTON

SmartWASH is a completely programmable automated wash system for your milking machine, with a selectable range of comprehensive wash scenarios.

With the versatility to manage any wash scenario for your plants requirements, SmartWASH enables you to meet all your hygiene standards and regulations.

The SmartWASH controller has been designed to provide total flexibility and constant reliability, and the modern touchscreen technology ensures a simple and user-friendly interface for the operator.

At the touch of a button you can select a wash scenario to suit your requirements and manage an efficient cleaning regime for your milking system.

When using a SmartWASH system, this means there is no requirement for operators to be handling chemicals.

What's Included:

- Smartwash Controller: with touchscreen interface
- Pneumatics enclosure: to control air driven valves
- Wash tub level sensors and temperature probes
- Chemical pumps: to safely dispense cleaning chemicals
- Stainless Steel pick up and divert valves: to control wash water flow and directions
- High capacity cold and hot water valves: ensures fast tub fill

ADVANTAGES

The SmartWASH system's programmed wash scenarios save time and labour.



Automatic wash control

Selectable wash scenarios created from a comprehensive menu, at the touch of a button.



Day by day programming

A repeatable, efficient and reliable wash cycle every time



Programmable acid, alkali or sanitiser washes

Accurate detergent dispensing minimises cleaning chemical wastage

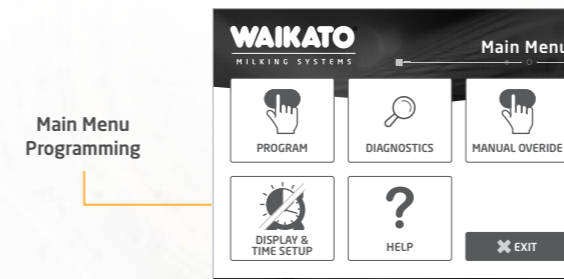

Main Menu Programming

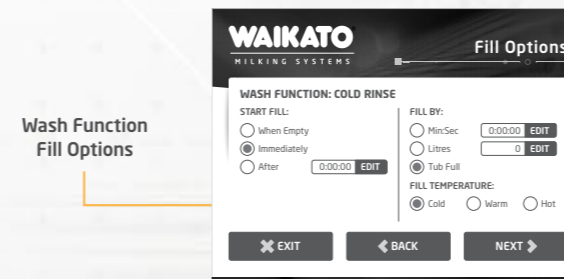

Wash Function Fill Options

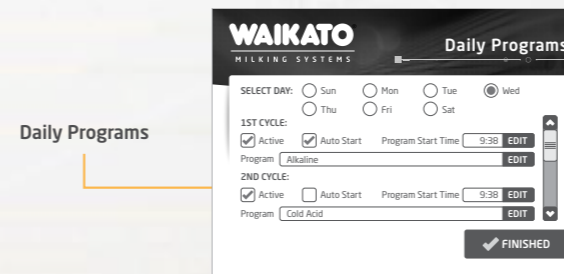

Daily Programs



Chemical Dispenser with optional chemical sensors

COWTRAQ™ COLLARS

Maximise your herd performance and farm efficiency with 24/7 heat and health monitoring for every cow.



KEEP YOUR HERD'S PERFORMANCE AND FARM EFFICIENCY ON TRACK

CowTRAQ™ collars provide 24/7 heat and health monitoring for every cow to maximise herd performance and farm efficiency.

CowTRAQ™ collars integrates with TracHQ™ software to provide you with real-time information and mobile alerts in a simple, user-friendly format. CowTRAQ™ collars identify each cow and keep track of her signs of heat, eating, rumination, standing, lying, walking and inactive behaviour 24/7 to provide you with insights on the fertility, health, well-being and nutritional status of individual cows and groups. TracHQ™ software provides you with real-time and relevant alerts, actionable to-do lists and reports to help you track, manage and control your herd. These data-driven decisions enable you to improve your farm management at a tactical and strategic level to improve your herd's performance, and ultimately, your bottom line.

What's Included:

- **Antenna:** The data from all the individual cows is continuously collected by the antenna. The short antenna has a range of at least 75 meters around the barn and the long antenna gives 250 meters when placed outside for grazing cows.
- **Processing unit:** The processing unit processes the data received by the antenna, analyses the individual data for each cow and turns it into relevant and actionable insights that can be viewed on PC, tablet and smartphone.
- **Cloud:** A continuously expanding range of services such as online backup, remote access, remote support and more are available through the cloud.
- **TracHQ Software:** Waikato Milking Systems TracHQ™ combines an unmatched range of monitoring features and management tools in a highly advanced, yet easy to use system including, health monitoring, heat detection, herd performance trends and identification.



ADVANTAGES

CowTRAQ™ collars and TracHQ™ software maximises your herd performance and farm efficiency 24/7.



Targeted management and optimisation

The system provides monitoring and tools for targeted management, precision feeding and labour efficiency.



Accurate heat detection

Improves reproduction results and increases labour efficiency by automatically tracking signs of heat.



Individual cow health monitoring

Detects health issues and metabolic disorders early to keep cows healthy and reduce veterinary treatment.



COWTRAQ™ COLLARS *continued...*

Maximise your herd performance and farm efficiency with 24/7 heat and health monitoring for every cow.

24/7 COW MANAGEMENT | ALL-IN-ONE

Waikato Milking Systems TracHQ™ software combines an unmatched range of monitoring features and management tools in a highly advanced, yet easy to use system.

Real-time information on all devices for multiple users

All team members have access to real-time and relevant insights, at any time and from anywhere with a PC, tablet or smartphone.



Identification*
Proven electronic ISO compliant cow identification in all your automated systems such as milking, feeding and sorting & routing equipment.
* Depends on whether the herd has RFID Ear Tags

Health Monitoring
Individual health management for early detection of health issues and intensive monitoring of transition cows and post-treatment recovery.

Heat Detection
Highly accurate heat detection with advice for the optimal insemination moment, as well as reproduction insights.

Herd Performance Trends
Chart the behaviour patterns of your groups and entire herd. Get group alerts when possible risks affect a group's performance. Evaluate the impact of management decisions on herd performance to make improvements.

Integration & Connection
Easily connect to Waikato Milking Systems DairyHQ™ Parlour Management System for a complete range of milking point controls, milk indicators, milk meters and milk analytical sensors.

ACTIONABLE HERD INSIGHTS REAL-TIME

The right information at the right time for the right person. Anytime and anywhere. A user friendly presentation of relevant information about individual cows and groups.

Heat detections

Worklist of cows in heat, including advice on their optimal insemination moment for effective insemination with the highest chance of conception and additional reproduction insights.

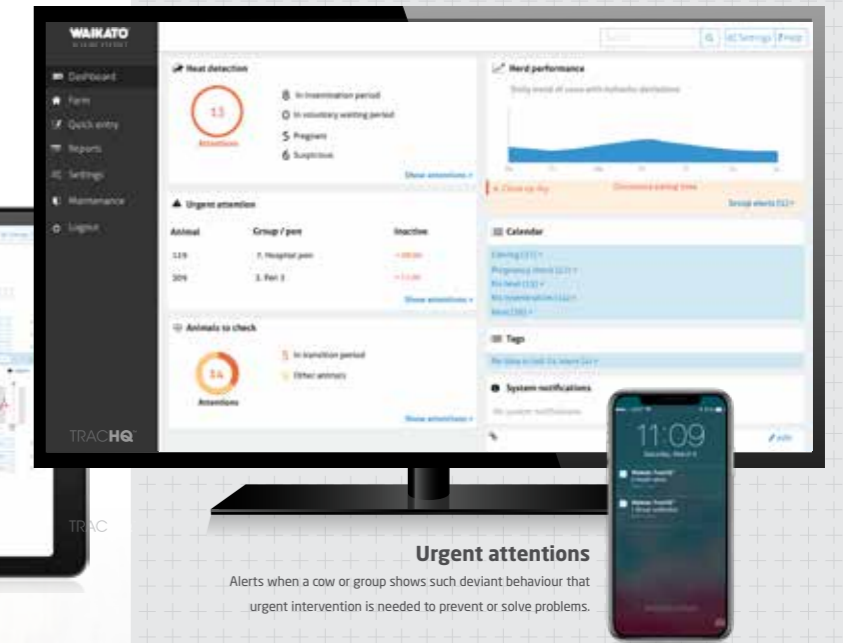
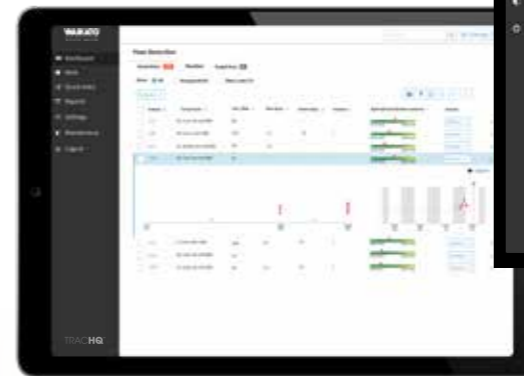

Dashboard
Widget-based overview of the most important alerts, to-do lists and reports.

Urgent attentions
Alerts when a cow or group shows such deviant behaviour that urgent intervention is needed to prevent or solve problems.



Animals to check
Worklist of animals to check including report of their deviant behavior that provides insight into possible health issues of each cow on the list.

Health Monitoring

- 48-hour report showing complete time spent of a cow across all activities.
- 60 day reports showing her day totals per activity including group benchmark.

Herd Performance Trends

- Group Eating Pattern: 48-hour report showing the percentage of all cows in a group eating simultaneously.
- 60 day reports showing her day totals per activity including herd benchmark.

DAIRYHQ™ PARLOUR MANAGEMENT SYSTEM

Drive your milking productivity and performance with intelligent and intuitive dairy management.



THE INTELLIGENCE BEHIND YOUR DAIRY AUTOMATION

The DairyHQ™ Parlour Management System provides you with intelligent and adaptive automation to drive your milking productivity and performance.

The DairyHQ™ Parlour Management System has been designed to provide you with the intelligence to drive your Waikato Milking automation and improve your dairy management, with a simple and intuitive user experience.

The DairyHQ™ CONTROL module allows you to make adjustments and fine tune your milking machine to optimise it for your farm's unique requirements. Each setting has an on-screen explanation to help the user get the most out of their milking machine.

As a modular state-of-the-art software system, new DairyHQ™ modules and features are continually being added allowing you to easily upgrade to improve your productivity and performance further, and stay up-to-date with industry developments.

What's Included:

- **DairyHQ™ application:** The DairyHQ™ web application, supported on a PC, tablet or mobile device that has access to a Google Chrome web browser.
- **DairyHQ™ server:** Secured storage of your DairyHQ™ milking and cow data.
- **SmartLink:** Waikato Milking System's communications gateway device, linking the Waikato Milking products to the DairyHQ™ server.
- **Wi-Fi Router:** Connects your devices to the DairyHQ™ server.



ADVANTAGES

DairyHQ™ CONTROL allows you to take control of your milking machine to drive your milking productivity and performance.



A complete visual overview of your rotary

The system is connected to all key milking components to provide you with real-time insights.



Wireless connectivity

Wireless connectivity allows you to connect to DairyHQ™ CONTROL using almost any phone, tablet or computer.



Modern, easy to use interface

A simple touch-screen interface provides an intuitive user experience, for fast data entry and work routines.



Please see the DairyHQ™ brochure or talk to your local Regional Sales Manager for the latest information on available modules.

DAIRYHQ™ continued...

Drive your milking productivity and performance with intelligent and intuitive dairy management.

DAIRY VIEW - A VIEW LIKE NO OTHER

The unique Dairy View feature in DairyHQ™ CONTROL allows you to monitor and view the entire platform with real-time milking alerts and status to indicate potential issues or warnings.

DairyHQ™ CONTROL offers the best of both worlds, integrating a wheel view as well as a list view, creating an interface like no other.

DairyHQ™ has been designed with large buttons and bold type for ease-of-use in a real-world dairy environment. Bring your own device technology (BYOD) allows DairyHQ™ to run on any device with Google Chrome web browser. Access DairyHQ™ anywhere in Wi-Fi range.

TAKE CONTROL OF YOUR MILKING MACHINE WITH DAIRYHQ™

The DairyHQ™ Dairy Management System allows you to make adjustments and fine tune your milking machine to optimise it for your farm's unique requirements - using almost any wireless device.



- **Features include:**
 - Air Sweep Delay
 - Air Sweep Time
 - Fixed Position Take-Off
 - Flow Value Detection
 - Let Down Delay
 - Maximum Milking Time
 - Minimum Milking Time
 - Milk/Wash Mode
 - Retention Bar Delay
 - Sensor Sensitivity
 - Take-Off Delay
 - Auto Cluster Drop Mode
 - Auto Park Delay
 - Auto Park to Idle Delay

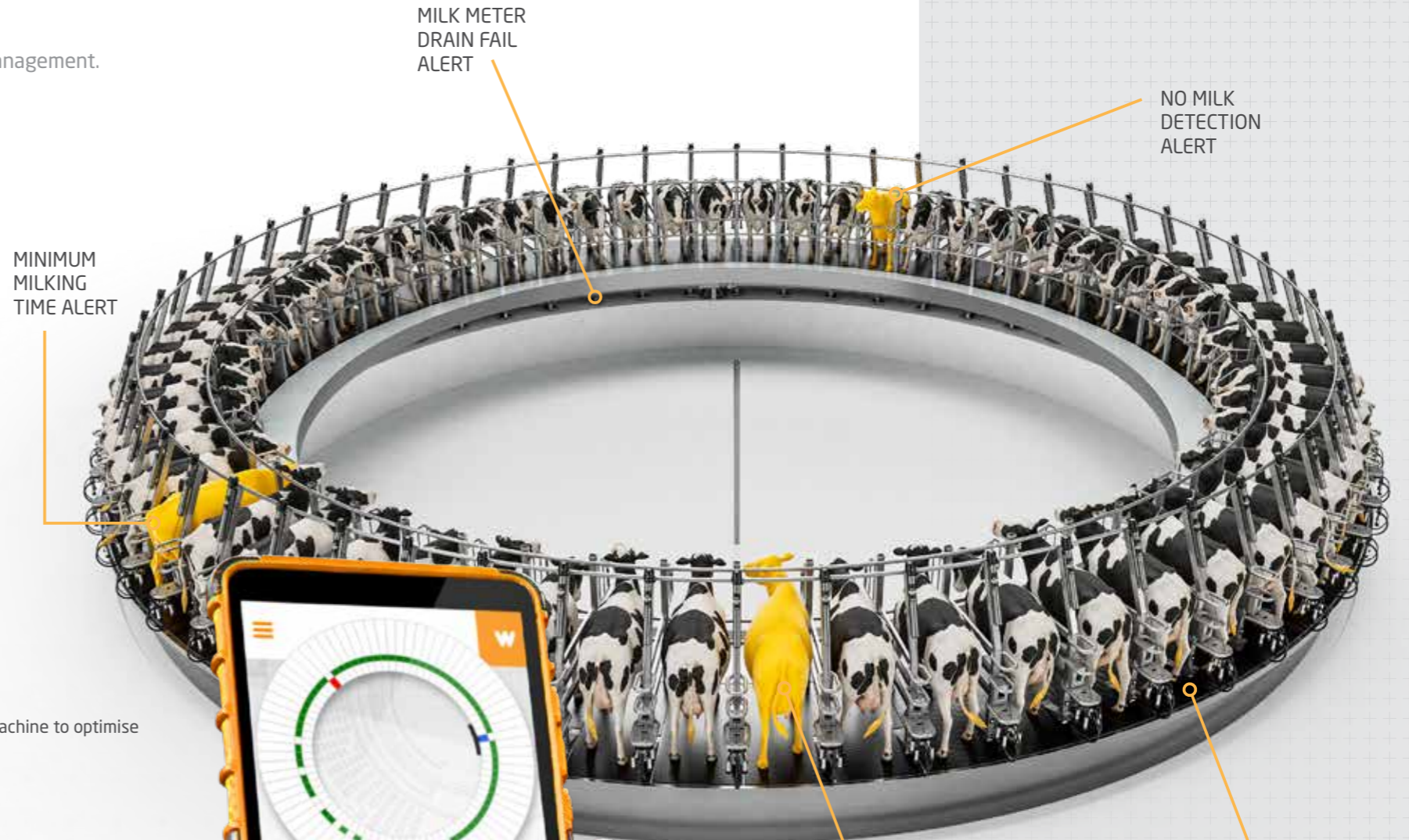

REAL-TIME MILKING ALERTS WITH DAIRY VIEW

The unique Dairy View feature in DairyHQ™ CONTROL allows you to monitor and view the entire platform with real-time milking alerts and status to indicate potential issues or warnings.

The simple touch-screen interface has been designed with large buttons and bold type for ease-of-use in a real-world dairy environment.

DAIRYHQ™ SORT *continued...*

Improve your dairy operation's efficiency and accuracy.

SORT COWS QUICKLY, ACCRUEATELY, AND AUTOMATICALLY ... WITH DAIRYHQ™ SORT

As an add-on module to DairyHQ™ Dairy Management System, DairyHQ™ SORT allows you to quickly and accurately sort your animals automatically, according to your specific instructions, with an intuitive and easy-to-use interface.

The DairyHQ™ SORT system incorporates an RFID Antenna that is fitted to a sort gate, which reads the identification tags of each animal as it approaches. With three-way sorting, the gate directs each animal to the left, right or straight ahead moments before the animal approaches the gate - depending on your pre-loaded or updated instructions. The gate operates quickly, quietly and smoothly, providing a calm environment for the animals to be sorted.

ADVANTAGES



REDUCE LABOUR COSTS

DairyHQ™ SORT eliminates the need to manually sort animals, freeing up labour to work on other important farm tasks.



INCREASE EFFICIENCY

By allowing you to automatically identify and sort animals that require attention, or require early health intervention, you can make better long-term decisions for your herd to increase your efficiency and stay ahead of the curve.



ACCURATE SORTING

DairyHQ™ SORT takes the guesswork out of manually identifying and sorting your animals by organising your herd according to your instructions - and allowing you to generate reports to double-check and review your sorting programmes.



USER FRIENDLY

The user-friendly interface features large touch-screen buttons and text areas to provide ease-of-use for operators in any milking environment on a smartphone, tablet, desktop computer, or on a large touch-screen display.



The DairyHQ™ SORT system allows you to:

- Create a sort function to automatically hold selected animals for health reasons, or for culling.
- Schedule animals to be sorted on a specific date and milking session.
- Select specific groups of animals to be sorted.
- Automatically sort animals that present at milking with faulty, or no identification tags, so they can be replaced.
- Sort animals with new identification tags that are not registered with your farm's herd database.
- Detect which animals in your herd were not present at milking time via the sort report.
- Import herd data from third party herd management software systems, or export herd data for other herd management systems.
- Apply a quick sort to a cow using the "Sort ASAP" feature if a cow presents with a problem and needs to be held for inspection at the end of milking - bypassing the need to set a date and reason for the sort.

A RANGE OF REPORTS AVAILABLE:



Groups



Herd identification



Manage your herd



Reporting on total sorts



Setting up sorts



Manage upcoming sorts

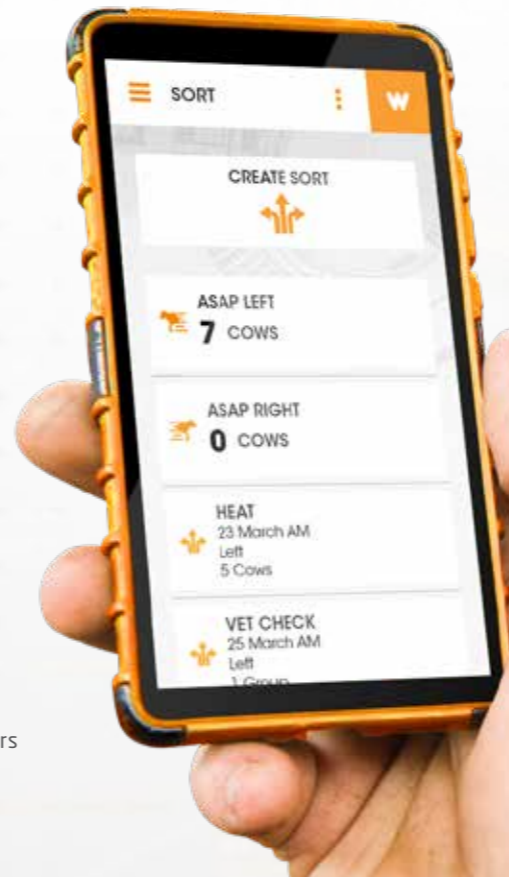

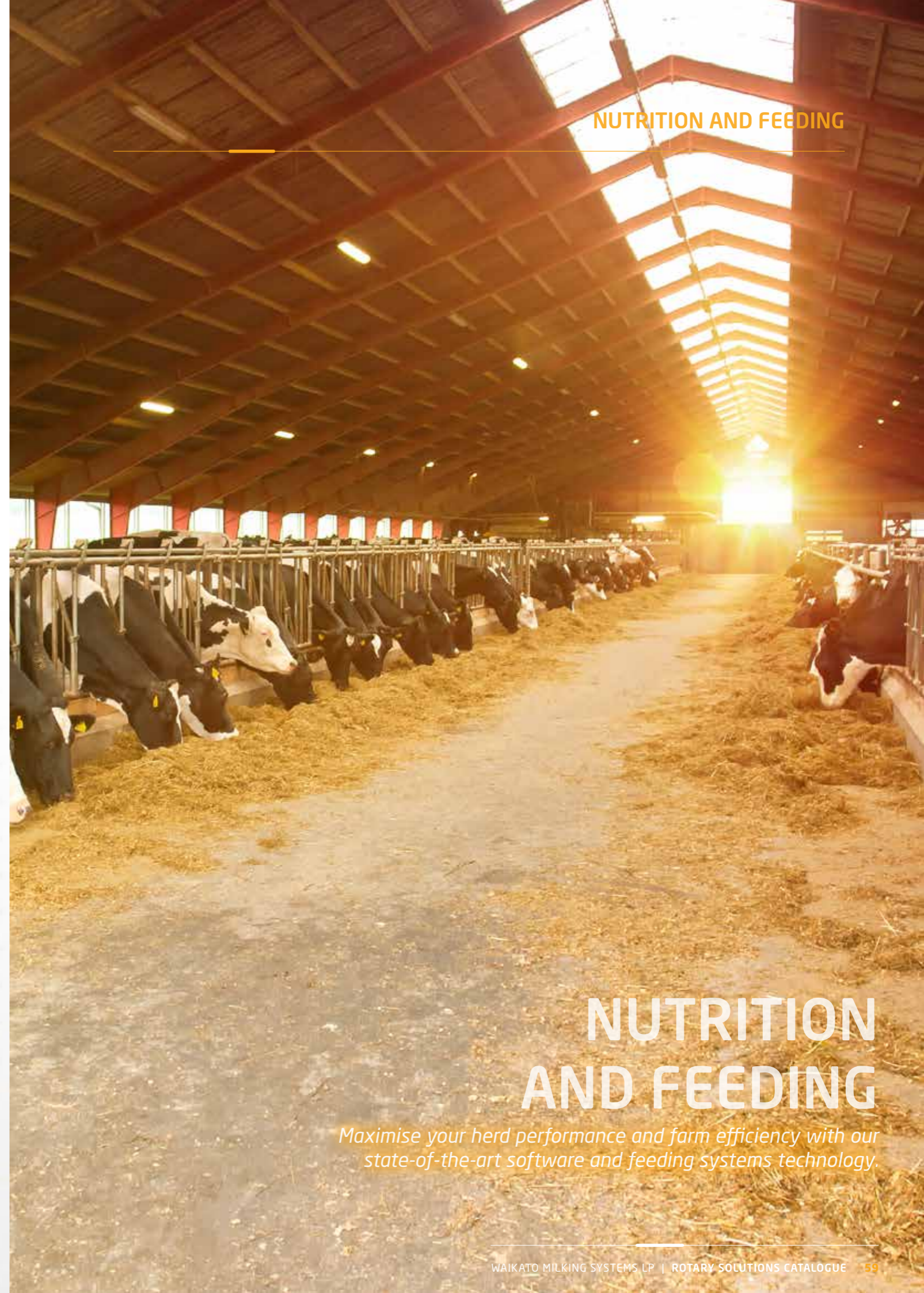

NUTRITION AND FEEDING

Maximise your herd performance and farm efficiency with our state-of-the-art software and feeding systems technology.

COWTRAQ™ COLLARS

Maximise your herd performance and farm efficiency with 24/7 heat and health monitoring for every cow.



KEEP YOUR HERD'S PERFORMANCE AND FARM EFFICIENCY ON TRACK

CowTRAQ™ collars provide 24/7 heat and health monitoring for every cow to maximise herd performance and farm efficiency.

CowTRAQ™ collars integrates with TracHQ™ software to provide you with real-time information and mobile alerts in a simple, user-friendly format. CowTRAQ™ collars identify each cow and keep track of her signs of heat, eating, rumination, standing, lying, walking and inactive behaviour 24/7 to provide you with insights on the fertility, health, well-being and nutritional status of individual cows and groups. TracHQ™ software provides you with real-time and relevant alerts, actionable to-do lists and reports to help you track, manage and control your herd. These data-driven decisions enable you to improve your farm management at a tactical and strategic level to improve your herd's performance, and ultimately, your bottom line.

What's Included:

- **Antenna:** The data from all the individual cows is continuously collected by the antenna. The short antenna has a range of at least 75 meters around the barn and the long antenna gives 250 meters when placed outside for grazing cows.
- **Processing unit:** The processing unit processes the data received by the antenna, analyses the individual data for each cow and turns it into relevant and actionable insights that can be viewed on PC, tablet and smartphone.
- **Cloud:** A continuously expanding range of services such as online backup, remote access, remote support and more are available through the cloud.
- **TracHQ Software:** Waikato Milking Systems TracHQ™ combines an unmatched range of monitoring features and management tools in a highly advanced, yet easy to use system including, health monitoring, heat detection, herd performance trends and identification.



ADVANTAGES

CowTRAQ™ collars and TracHQ™ software maximises your herd performance and farm efficiency 24/7.



Targeted management and optimisation

The system provides monitoring and tools for targeted management, precision feeding and labour efficiency.



Accurate heat detection

Improves reproduction results and increases labour efficiency by automatically tracking signs of heat.



Individual cow health monitoring

Detects health issues and metabolic disorders early to keep cows healthy and reduce veterinary treatment.



COWTRAQ™ COLLARS *continued...*

Maximise your herd performance and farm efficiency with 24/7 heat and health monitoring for every cow.

24/7 COW MANAGEMENT | ALL-IN-ONE

Waikato Milking Systems TracHQ™ software combines an unmatched range of monitoring features and management tools in a highly advanced, yet easy to use system.

Real-time information on all devices for multiple users

All team members have access to real-time and relevant insights, at any time and from anywhere with a PC, tablet or smartphone.



Identification*

Proven electronic ISO compliant cow identification in all your automated systems such as milking, feeding and sorting & routing equipment.

* Depends on whether the herd has RFID Ear Tags



Health Monitoring

Individual health management for early detection of health issues and intensive monitoring of transition cows and post-treatment recovery.



Heat Detection

Highly accurate heat detection with advice for the optimal insemination moment, as well as reproduction insights.



Herd Performance Trends

Chart the behaviour patterns of your groups and entire herd. Get group alerts when possible risks affect a group's performance. Evaluate the impact of management decisions on herd performance to make improvements.



Integration & Connection

Easily connect to Waikato Milking Systems DairyHQ™ Parlour Management System for a complete range of milking point controls, milk indicators, milk meters and milk analytical sensors.

ACTIONABLE HERD INSIGHTS REAL-TIME

The right information at the right time for the right person. Anytime and anywhere. A user friendly presentation of relevant information about individual cows and groups.

Dashboard

Widget-based overview of the most important alerts, to-do lists and reports.

Heat detections

Worklist of cows in heat, including advice on their optimal insemination moment for effective insemination with the highest chance of conception and additional reproduction insights.

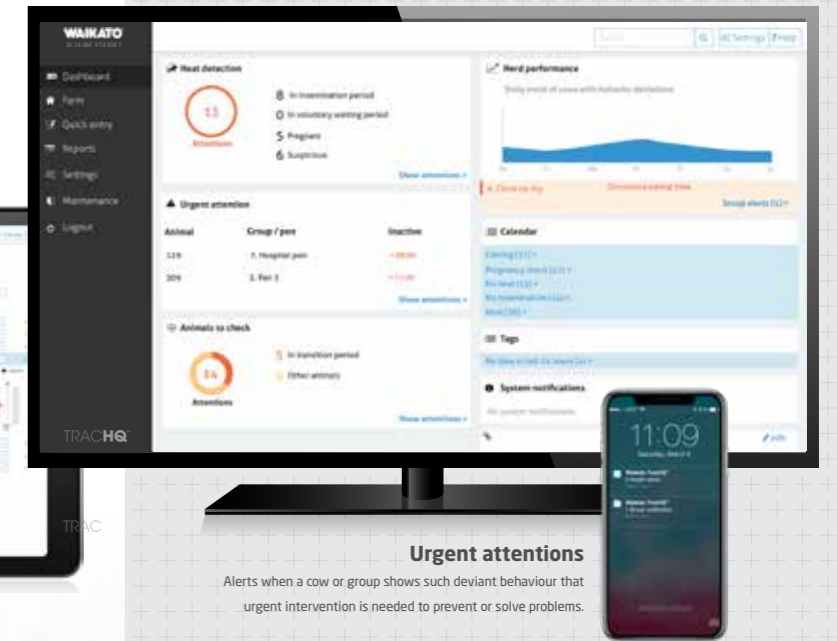
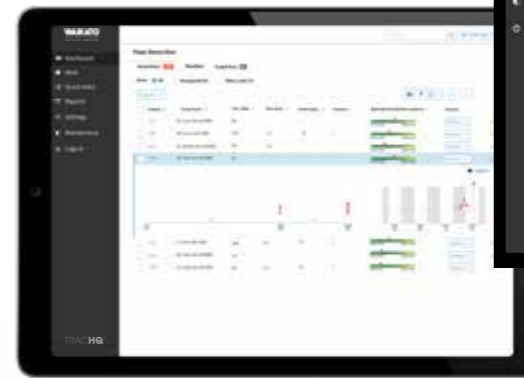

Urgent attentions

Alerts when a cow or group shows such deviant behaviour that urgent intervention is needed to prevent or solve problems.



Animals to check

Worklist of animals to check including report of their deviant behavior that provides insight into possible health issues of each cow on the list.



Health Monitoring

- 48-hour report showing complete time spent of a cow across all activities.
- 60 day reports showing her day totals per activity including group benchmark.

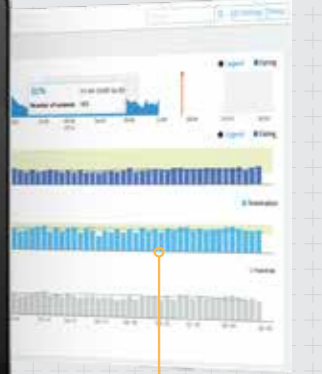

Herd Performance Trends

- Group Eating Pattern: 48-hour report showing the percentage of all cows in a group eating simultaneously.
- 60 day reports showing her day totals per activity including herd benchmark.

TRACHQ™ SOFTWARE

Track your herd in real-time to maximise your herd performance and farm efficiency.

KEEP YOUR HERD'S PERFORMANCE ON TRACK



Waikato Milking Systems TrachQ™ provides you with insights on every cow so you can maximise your herd performance and farm efficiency by providing real-time information and mobile alerts in a simple, user-friendly format.

TrachQ™ turns data from CowTRAQ™ collars into relevant and real-time alerts, to-do lists, reports and barn maps to help manage and control your herd.

These easy to understand and actionable insights are delivered directly to your PC, tablet or smartphone.

TrachQ™ allows you to make data-driven decisions and improve your farm management at a tactical and strategic level using the behavioural insights of individual cows and the entire herd.

Health monitoring information allows you to automatically focus on the right cows, at the right time, with the right treatment to keep them healthy, fertile and productive.

What's Included:

- The TrachQ™ Software is an **HTML5 web application** viewable on any of your internet-ready devices.
- The **software license** is included with the purchase of your collar equipment.
- Note: **TrachQ™ Antenna** and **controller hardware** is required to receive collar data

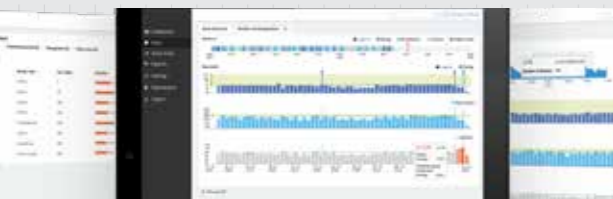

ADVANTAGES

Waikato Milking Systems TrachQ™ provides insights to maximise your herd performance and farm efficiency.



User-friendly, actionable herd insights

Heat detections, urgent attentions, animals to check, health monitoring & herd performance trends.



Make data-driven decisions

Monitor production for targeted management, and optimise production through precision feeding.



Real-time information for multiple users

All team members have access to relevant insights at any time, from any device.

Dashboard

Widget-based overview of the most important alerts, to-do lists and reports.

Heat detections

Worklist of cows in heat, including advice on their optimal insemination moment for effective insemination with the highest chance of conception and additional reproduction insights.



Urgent attentions

Alerts when a cow or group shows such deviant behaviour that urgent intervention is needed to prevent or solve problems.



HEAT DETECTION

Improve reproduction results, increase labour efficiency.

TrachQ™ detects heats with outstanding accuracy, helping dairy farmers worldwide improve reproduction results and labour efficiency. It automatically tracks the signs of heat - such as increased activity, sniffing, chin resting and mounting behaviour - of all your cows, 24 hours a day. The system shows a clear list of all cows in heat with their optimal insemination moment for effective insemination with the highest chance of conception. It also provides additional reproduction insights, helping you to find cows with irregular heats, non-cycling cows and non-pregnant cows.



HERD PERFORMANCE TRENDS

Evaluate group and herd behaviour, improve farm management.

TrachQ™ charts the behaviour patterns of your groups and entire herd. They show you how external factors and management decisions influence the herd's performance. The system sends a group alert when it detects abnormalities among a percentage of the cows in a group, allowing you to respond to external factors posing a risk to their health, milk production and reproduction. At strategic level, group behaviour reports on herd performance insights offering a valuable tool to measure and evaluate the impact of (changed) feeding strategies, housing conditions, grazing and milking procedures. So you have fact-based information to continuously optimise your management and improve your bottom line.

TRACHQ™ SOFTWARE *continued...*

Track your herd in real-time to maximise your herd performance and farm efficiency.

THE RIGHT INFORMATION AT THE RIGHT TIME

...for the right person. Anytime and anywhere.

Animals to check

Worklist of animals to check including report of deviant behaviour that provides insight into possible health issues of each cow on the list.

Health Monitoring

- 48-hour report showing complete time spent of a cow across all activities.
- 60 day reports showing her day totals per activity including group benchmark.

Herd Performance Trends

- Group Eating Pattern: 48-hour report showing the percentage of all cows in a group eating simultaneously.
- 60 day group reports showing day totals per activity including herd benchmark.

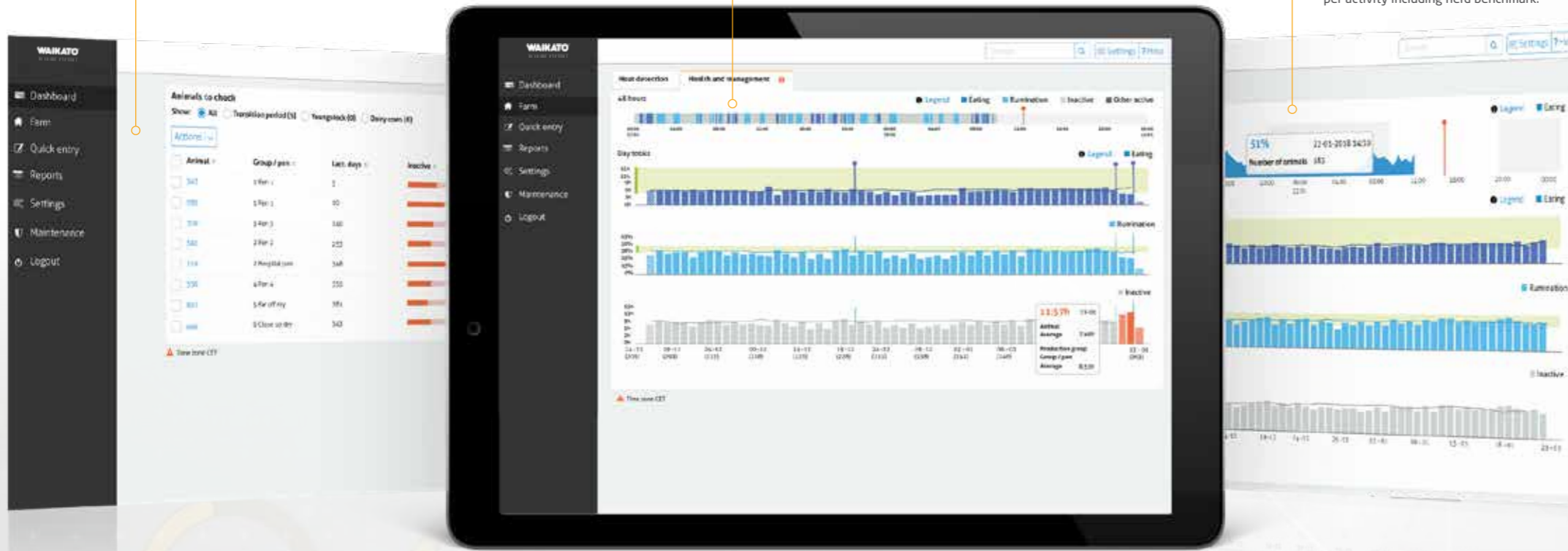

HEALTH MONITORING

Keep cows healthy, fertile and productive

TrachQ™ Health Monitoring is an essential tool to keep your cows healthy, fertile and productive. CowTraQ™ Collars register a combination of three behavioral aspects, giving the most precise and complete insight into the health status of each cow. The system compares all behaviour with standards for optimum condition, the previous behaviour of the cow and the behaviour of the group she is in and detects changes or abnormalities. It provides the earliest and most reliable health alerts for cows that need urgent attention and shows a list of cows that need to be checked today, allowing you to treat health issues before they become problems. It also enables you to intensively monitor transition cows and post-treatment recovery.

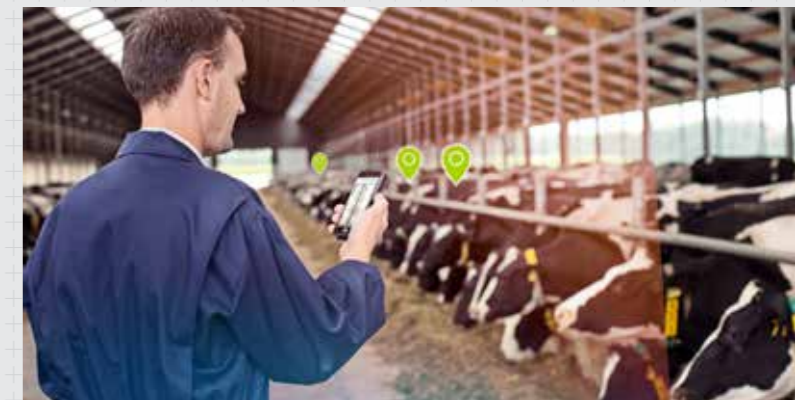

COW LOCATION (USA AND EUROPE ONLY)

Stop searching, start finding.

Finding cows needing to be checked, inseminated, treated or fetched, was never as easy and time-saving as it is with TrachQ™ Cow Location. The system automatically locates the cows you need to find. It accurately shows and follows the real-time position of individual or multiple cows on your barn map with one click on your PC, tablet or smartphone. TrachQ™ Cow Location is fully integrated with Heat Detection, Health Monitoring and Herd Performance Trends. As a result, responding to cows that need attention is easier and quicker than ever. This saves you and your team a lot of time and aggravation every day and at the same time ensures a better follow-up of alerts.

WHERE DO YOU WANT TO IMPROVE?

- Improve Reproduction Results?
- Better cow health and condition?
- Improve farm management?
- Get a more productive and sustainable herd?
- Increase labour efficiency and effectiveness?
- Save costs?
- Improve welfare and sustainable production?
- More enjoyable work?

DAIRYHQ™ PARLOUR MANAGEMENT SYSTEM

Drive your milking productivity and performance with intelligent and intuitive dairy management.



THE INTELLIGENCE BEHIND YOUR DAIRY AUTOMATION

The DairyHQ™ Parlour Management System provides you with intelligent and adaptive automation to drive your milking productivity and performance.

The DairyHQ™ Parlour Management System has been designed to provide you with the intelligence to drive your Waikato Milking automation and improve your dairy management, with a simple and intuitive user experience.

The DairyHQ™ CONTROL module allows you to make adjustments and fine tune your milking machine to optimise it for your farm's unique requirements. Each setting has an on-screen explanation to help the user get the most out of their milking machine.

As a modular state-of-the-art software system, new DairyHQ™ modules and features are continually being added allowing you to easily upgrade to improve your productivity and performance further, and stay up-to-date with industry developments.

What's Included:

- **DairyHQ™ application:** The DairyHQ™ web application, supported on a PC, tablet or mobile device that has access to a Google Chrome web browser.
- **DairyHQ™ server:** Secured storage of your DairyHQ™ milking and cow data.
- **SmartLink:** Waikato Milking System's communications gateway device, linking the Waikato Milking products to the DairyHQ™ server.
- **Wi-Fi Router:** Connects your devices to the DairyHQ™ server.



ADVANTAGES

DairyHQ™ CONTROL allows you to take control of your milking machine to drive your milking productivity and performance.



A complete visual overview of your rotary

The system is connected to all key milking components to provide you with real-time insights.



Wireless connectivity

Wireless connectivity allows you to connect to DairyHQ™ CONTROL using almost any phone, tablet or computer.



Modern, easy to use interface

A simple touch-screen interface provides an intuitive user experience, for fast data entry and work routines.

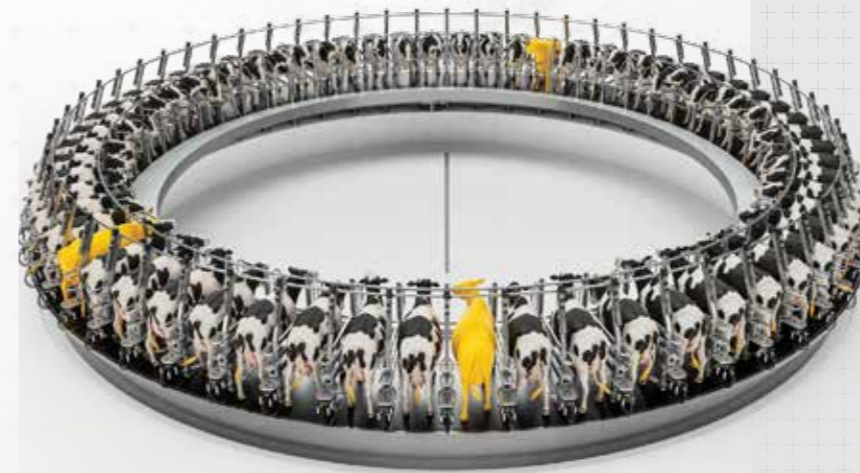

Please see the DairyHQ™ brochure or talk to your local Regional Sales Manager for the latest information on available modules.

DAIRYHQ™ *continued...*

Drive your milking productivity and performance with intelligent and intuitive dairy management.

DAIRY VIEW - A VIEW LIKE NO OTHER

The unique Dairy View feature in DairyHQ™ CONTROL allows you to monitor and view the entire platform with real-time milking alerts and status to indicate potential issues or warnings.

DairyHQ™ CONTROL offers the best of both worlds, integrating a wheel view as well as a list view, creating an interface like no other.

DairyHQ™ has been designed with large buttons and bold type for ease-of-use in a real-world dairy environment. Bring your own device technology (BYOD) allows DairyHQ™ to run on any device with Google Chrome web browser. Access DairyHQ™ anywhere in Wi-Fi range.

TAKE CONTROL OF YOUR MILKING MACHINE WITH DAIRYHQ™

The DairyHQ™ Dairy Management System allows you to make adjustments and fine tune your milking machine to optimise it for your farm's unique requirements - using almost any wireless device.



- **Features include:**
 - Air Sweep Delay
 - Air Sweep Time
 - Fixed Position Take-Off
 - Flow Value Detection
 - Let Down Delay
 - Maximum Milking Time
 - Minimum Milking Time
 - Milk/Wash Mode
 - Retention Bar Delay
 - Sensor Sensitivity
 - Take-Off Delay
 - Auto Cluster Drop Mode
 - Auto Park Delay
 - Auto Park to Idle Delay

MINIMUM MILKING TIME ALERT

MILK METER DRAIN FAIL ALERT

NO MILK DETECTION ALERT



MANUAL MILKING

MILKING MODE IDLE

REAL-TIME MILKING ALERTS WITH DAIRY VIEW

The unique Dairy View feature in DairyHQ™ CONTROL allows you to monitor and view the entire platform with real-time milking alerts and status to indicate potential issues or warnings.

The simple touch-screen interface has been designed with large buttons and bold type for ease-of-use in a real-world dairy environment.

DAIRYHQ™ SORT *continued...*

Improve your dairy operation's efficiency and accuracy.

SORT COWS QUICKLY, ACCURATELY, AND AUTOMATICALLY ... WITH DAIRYHQ™ SORT

As an add-on module to DairyHQ™ Dairy Management System, DairyHQ™ SORT allows you to quickly and accurately sort your animals automatically, according to your specific instructions, with an intuitive and easy-to-use interface.

The DairyHQ™ SORT system incorporates an RFID Antenna that is fitted to a sort gate, which reads the identification tags of each animal as it approaches. With three-way sorting, the gate directs each animal to the left, right or straight ahead moments before the animal approaches the gate - depending on your pre-loaded or updated instructions. The gate operates quickly, quietly and smoothly, providing a calm environment for the animals to be sorted.

ADVANTAGES



REDUCE LABOUR COSTS

DairyHQ™ SORT eliminates the need to manually sort animals, freeing up labour to work on other important farm tasks.



INCREASE EFFICIENCY

By allowing you to automatically identify and sort animals that require attention, or require early health intervention, you can make better long-term decisions for your herd to increase your efficiency and stay ahead of the curve.



ACCURATE SORTING

DairyHQ™ SORT takes the guesswork out of manually identifying and sorting your animals by organising your herd according to your instructions - and allowing you to generate reports to double-check and review your sorting programmes.



USER FRIENDLY

The user-friendly interface features large touch-screen buttons and text areas to provide ease-of-use for operators in any milking environment on a smartphone, tablet, desktop computer, or on a large touch-screen display.



The DairyHQ™ SORT system allows you to:

- Create a sort function to automatically hold selected animals for health reasons, or for culling.
- Schedule animals to be sorted on a specific date and milking session.
- Select specific groups of animals to be sorted.
- Automatically sort animals that present at milking with faulty, or no identification tags, so they can be replaced.
- Sort animals with new identification tags that are not registered with your farm's herd database.
- Detect which animals in your herd were not present at milking time via the sort report.
- Import herd data from third party herd management software systems, or export herd data for other herd management systems.
- Apply a quick sort to a cow using the "Sort ASAP" feature if a cow presents with a problem and needs to be held for inspection at the end of milking - bypassing the need to set a date and reason for the sort.

A RANGE OF REPORTS AVAILABLE:



Groups



Herd identification



Manage your herd



Reporting on total sorts



Setting up sorts



Manage upcoming sorts

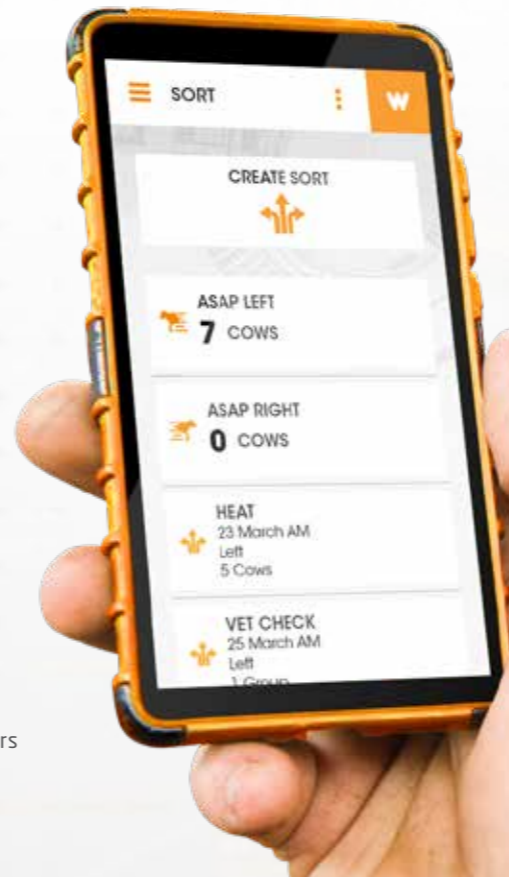

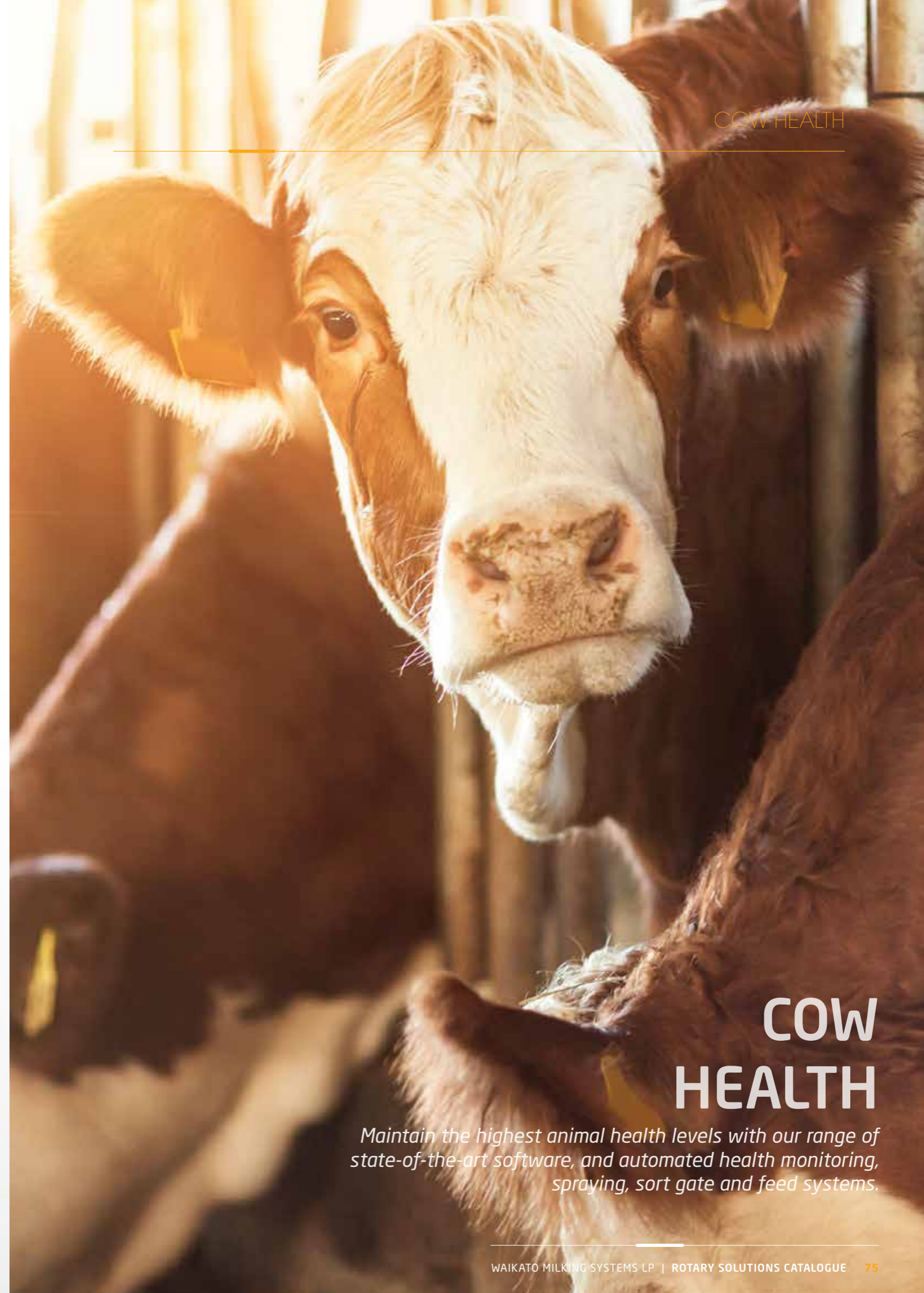

COW HEALTH

Maintain the highest animal health levels with our range of state-of-the-art software, and automated health monitoring, spraying, sort gate and feed systems.

COWTRAQ™ COLLARS

Maximise your herd performance and farm efficiency with 24/7 heat and health monitoring for every cow.



KEEP YOUR HERD'S PERFORMANCE AND FARM EFFICIENCY ON TRACK

CowTRAQ™ collars provide 24/7 heat and health monitoring for every cow to maximise herd performance and farm efficiency.

CowTRAQ™ collars integrates with TracHQ™ software to provide you with real-time information and mobile alerts in a simple, user-friendly format. CowTRAQ™ collars identify each cow and keep track of her signs of heat, eating, rumination, standing, lying, walking and inactive behaviour 24/7 to provide you with insights on the fertility, health, well-being and nutritional status of individual cows and groups. TracHQ™ software provides you with real-time and relevant alerts, actionable to-do lists and reports to help you track, manage and control your herd. These data-driven decisions enable you to improve your farm management at a tactical and strategic level to improve your herd's performance, and ultimately, your bottom line.

What's Included:

- **Antenna:** The data from all the individual cows is continuously collected by the antenna. The short antenna has a range of at least 75 meters around the barn and the long antenna gives 250 meters when placed outside for grazing cows.
- **Processing unit:** The processing unit processes the data received by the antenna, analyses the individual data for each cow and turns it into relevant and actionable insights that can be viewed on PC, tablet and smartphone.
- **Cloud:** A continuously expanding range of services such as online backup, remote access, remote support and more are available through the cloud.
- **TracHQ Software:** Waikato Milking Systems TracHQ™ combines an unmatched range of monitoring features and management tools in a highly advanced, yet easy to use system including, health monitoring, heat detection, herd performance trends and identification.



ADVANTAGES

CowTRAQ™ collars and TracHQ™ software maximises your herd performance and farm efficiency 24/7.



Targeted management and optimisation

The system provides monitoring and tools for targeted management, precision feeding and labour efficiency.



Accurate heat detection

Improves reproduction results and increases labour efficiency by automatically tracking signs of heat.



Individual cow health monitoring

Detects health issues and metabolic disorders early to keep cows healthy and reduce veterinary treatment.



COWTRAQ™ COLLARS *continued...*

Maximise your herd performance and farm efficiency with 24/7 heat and health monitoring for every cow.

24/7 COW MANAGEMENT | ALL-IN-ONE

Waikato Milking Systems TracHQ™ software combines an unmatched range of monitoring features and management tools in a highly advanced, yet easy to use system.

Real-time information on all devices for multiple users

All team members have access to real-time and relevant insights, at any time and from anywhere with a PC, tablet or smartphone.



Identification*

Proven electronic ISO compliant cow identification in all your automated systems such as milking, feeding and sorting & routing equipment.

* Depends on whether the herd has RFID Ear Tags



Health Monitoring

Individual health management for early detection of health issues and intensive monitoring of transition cows and post-treatment recovery.



Heat Detection

Highly accurate heat detection with advice for the optimal insemination moment, as well as reproduction insights.



Herd Performance Trends

Chart the behaviour patterns of your groups and entire herd. Get group alerts when possible risks affect a group's performance. Evaluate the impact of management decisions on herd performance to make improvements.



Integration & Connection

Easily connect to Waikato Milking Systems DairyHQ™ Parlour Management System for a complete range of milking point controls, milk indicators, milk meters and milk analytical sensors.

ACTIONABLE HERD INSIGHTS REAL-TIME

The right information at the right time for the right person. Anytime and anywhere. A user friendly presentation of relevant information about individual cows and groups.

Dashboard

Widget-based overview of the most important alerts, to-do lists and reports.

Heat detections

Worklist of cows in heat, including advice on their optimal insemination moment for effective insemination with the highest chance of conception and additional reproduction insights.

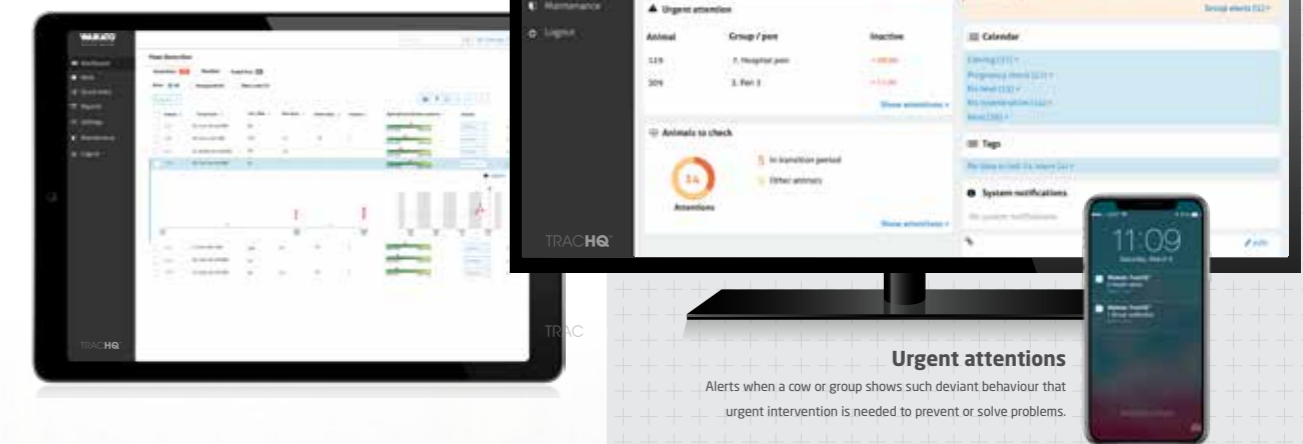

Urgent attentions

Alerts when a cow or group shows such deviant behaviour that urgent intervention is needed to prevent or solve problems.



Animals to check

Worklist of animals to check including report of their deviant behavior that provides insight into possible health issues of each cow on the list.

Health Monitoring

- 48-hour report showing complete time spent of a cow across all activities.
- 60 day reports showing her day totals per activity including group benchmark.

Herd Performance Trends

- Group Eating Pattern: 48-hour report showing the percentage of all cows in a group eating simultaneously.
- 60 day reports showing her day totals per activity including herd benchmark.

TRACHQ™ SOFTWARE

Track your herd in real-time to maximise your herd performance and farm efficiency.

KEEP YOUR HERD'S PERFORMANCE ON TRACK



Waikato Milking Systems TrachQ™ provides you with insights on every cow so you can maximise your herd performance and farm efficiency by providing real-time information and mobile alerts in a simple, user-friendly format.

TrachQ™ turns data from CowTRAQ™ collars into relevant and real-time alerts, to-do lists, reports and barn maps to help manage and control your herd.

These easy to understand and actionable insights are delivered directly to your PC, tablet or smartphone.

TrachQ™ allows you to make data-driven decisions and improve your farm management at a tactical and strategic level using the behavioural insights of individual cows and the entire herd.

Health monitoring information allows you to automatically focus on the right cows, at the right time, with the right treatment to keep them healthy, fertile and productive.

What's Included:

- The TrachQ™ Software is an **HTML5 web application** viewable on any of your internet-ready devices.
- The **software license** is included with the purchase of your collar equipment.
- Note: **TrachQ™ Antenna** and **controller hardware** is required to receive collar data

ADVANTAGES

Waikato Milking Systems TrachQ™ provides insights to maximise your herd performance and farm efficiency.



User-friendly, actionable herd insights

Heat detections, urgent attentions, animals to check, health monitoring & herd performance trends.



Make data-driven decisions

Monitor production for targeted management, and optimise production through precision feeding.



Real-time information for multiple users

All team members have access to relevant insights at any time, from any device.

Dashboard

Widget-based overview of the most important alerts, to-do lists and reports.

Heat detections

Worklist of cows in heat, including advice on their optimal insemination moment for effective insemination with the highest chance of conception and additional reproduction insights.



Urgent attentions

Alerts when a cow or group shows such deviant behaviour that urgent intervention is needed to prevent or solve problems.



HEAT DETECTION

Improve reproduction results, increase labour efficiency.

TrachQ™ detects heats with outstanding accuracy, helping dairy farmers worldwide improve reproduction results and labour efficiency. It automatically tracks the signs of heat - such as increased activity, sniffing, chin resting and mounting behaviour - of all your cows, 24 hours a day. The system shows a clear list of all cows in heat with their optimal insemination moment for effective insemination with the highest chance of conception. It also provides additional reproduction insights, helping you to find cows with irregular heats, non-cycling cows and non-pregnant cows.



HERD PERFORMANCE TRENDS

Evaluate group and herd behaviour, improve farm management.

TrachQ™ charts the behaviour patterns of your groups and entire herd. They show you how external factors and management decisions influence the herd's performance. The system sends a group alert when it detects abnormalities among a percentage of the cows in a group, allowing you to respond to external factors posing a risk to their health, milk production and reproduction. At strategic level, group behaviour reports on herd performance insights offering a valuable tool to measure and evaluate the impact of (changed) feeding strategies, housing conditions, grazing and milking procedures. So you have fact-based information to continuously optimise your management and improve your bottom line.

TRACHQ™ SOFTWARE *continued...*

Track your herd in real-time to maximise your herd performance and farm efficiency.

THE RIGHT INFORMATION AT THE RIGHT TIME

...for the right person. Anytime and anywhere.

Animals to check

Worklist of animals to check including report of deviant behaviour that provides insight into possible health issues of each cow on the list.

Health Monitoring

- 48-hour report showing complete time spent of a cow across all activities.
- 60 day reports showing her day totals per activity including group benchmark.

Herd Performance Trends

- Group Eating Pattern: 48-hour report showing the percentage of all cows in a group eating simultaneously.
- 60 day group reports showing day totals per activity including herd benchmark.

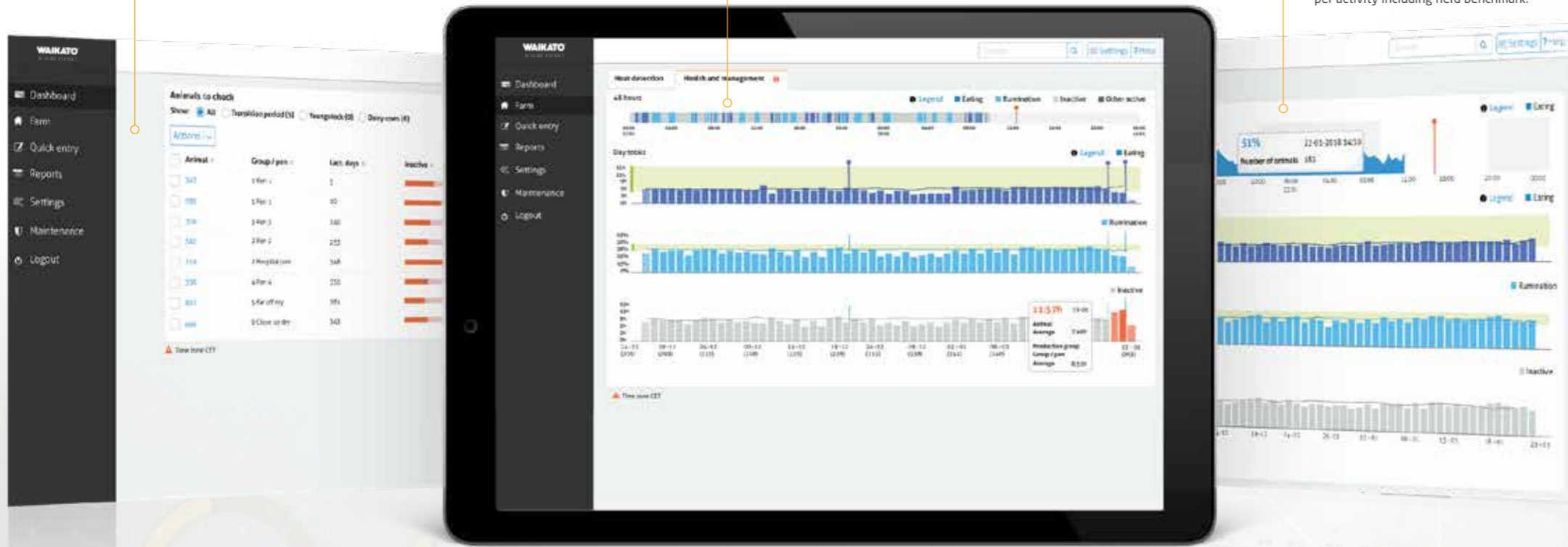

HEALTH MONITORING

Keep cows healthy, fertile and productive

TrachQ™ Health Monitoring is an essential tool to keep your cows healthy, fertile and productive. CowTraQ™ Collars register a combination of three behavioral aspects, giving the most precise and complete insight into the health status of each cow. The system compares all behaviour with standards for optimum condition, the previous behaviour of the cow and the behaviour of the group she is in and detects changes or abnormalities. It provides the earliest and most reliable health alerts for cows that need urgent attention and shows a list of cows that need to be checked today, allowing you to treat health issues before they become problems. It also enables you to intensively monitor transition cows and post-treatment recovery.

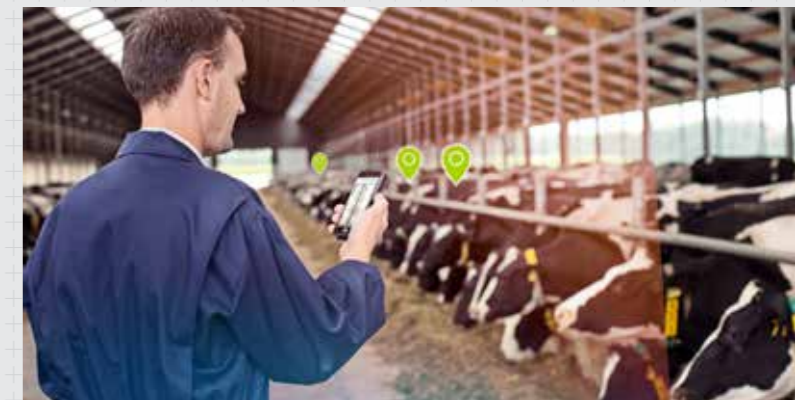

COW LOCATION (USA AND EUROPE ONLY)

Stop searching, start finding.

Finding cows needing to be checked, inseminated, treated or fetched, was never as easy and time-saving as it is with TrachQ™ Cow Location. The system automatically locates the cows you need to find. It accurately shows and follows the real-time position of individual or multiple cows on your barn map with one click on your PC, tablet or smartphone. TrachQ™ Cow Location is fully integrated with Heat Detection, Health Monitoring and Herd Performance Trends. As a result, responding to cows that need attention is easier and quicker than ever. This saves you and your team a lot of time and aggravation every day and at the same time ensures a better follow-up of alerts.

WHERE DO YOU WANT TO IMPROVE?

- Improve Reproduction Results?
- Better cow health and condition?
- Improve farm management?
- Get a more productive and sustainable herd?
- Increase labour efficiency and effectiveness?
- Save costs?
- Improve welfare and sustainable production?
- More enjoyable work?

SMARTD-TECT UDDER HEALTH DETECTION

Reduce your labour and increase your productivity with SmartD-TECTs automation technology.

REDUCE LABOUR. INCREASE PRODUCTIVITY

SmartD-TECT performs a health analysis of each quarter of the udder by automating your pre-milking stimulation and udder health monitoring without adding additional tasks for the operator.

SmartD-TECT allows you to make data-driven decisions for your herd's health reducing the chance of any loss in productivity. The pulsator milks each quarter separately to measure the conductivity of each teat during the pre-milking phase. Individual quarter conductivity allows SmartD-TECT to eliminate issues with dilution between quarters to provide highly accurate alerts for potential health problems. If any quarters are abnormal, an alert is issued up to four days before visual signs appear, providing the opportunity for early treatment intervention. The pre-milking pulsation for quarter testing also promotes a natural let down response from the cows, eliminating precious time normally spent manually stimulating teats to trigger milk flow. By having the same milking routine each time, cows let their milk down faster, more consistently and at a higher average flow rate. By removing the variabilities of operators, SmartD-TECT provides consistency in performance and productivity advantages that no other conventional milking system offers.

What's Included:

- **SmartD-TECT Pulsator:** Controls individual pulsation signals to the cluster allowing each quarter to be milked separately at the start of milking.
- **SmartD-TECT Sensor:** are attached to the milk line at every cluster to measure the conductivity of the milk from each cow. The results are sent to the pulsator for interpretation.
- **SmartD-TECT Controller:** Is a touchscreen interface that controls SmartD-TECT's sensitivity settings.

ADVANTAGES

SmartD-TECT provides peace of mind for a consistent milking routine and the automated detection of problematic animals and potential udder health issues, reducing treatment time and cost.



Udder Health Monitoring

Identify the onset of mastitis up to four days before visual signs are evident to make decisions earlier.



Individual Quarter Testing

The pulsator milks each quarter separately and measures the conductivity of each for a more accurate alert.



Eliminate Forestripping

Automate your milking stimulation and prep routine to reduce labour and increase your productivity.



During the pre-milking phase, SmartD-TECT milks each quarter separately and measures the conductivity



SMARTSPRAY AUTOMATED TEAT SPRAYING

Automated teat spraying that reduces your labour and increases your efficiency.

MAXIMUM TEAT COVERAGE, WITH MINIMAL LABOUR

SmartSPRAY is an innovative automatic teat spray system designed specifically for rotary dairies, that replaces the need for manual teat spraying and teat dipping before and after milking.

With no operator input required during milking, SmartSPRAY greatly reduces labour while ensuring maximum coverage regardless of the cow's position in the bail. The spray nozzles on the bullets can be rotated to cater for a wide variety of cow sizes and different breeds. The bullets are easy to clean and made of durable material designed to withstand years of harsh treatment under the cows at milking time.

The SmartSPRAY system is controlled directly by Waikato ECR-S or ECR Plus cup removers. When combined with Waikato Milking Systems cup removers, SmartSPRAY can be set so it doesn't spray animals that are returning to the operator.

It's possible to fit the SmartSPRAY to other rotary systems using an interface to connect with other types of cup removers.

What's Included:

- **2 or 4 spray nozzles:** built into the Bullet leg spreader (per stall), 2 nozzles are standard, 4 are used for pre & post spraying
- **Electronic solenoid valve:** for accurate volume dispensing
- **On platform chemical storage vessel**
- **Off platform Chemical mixing vessel:** for safe and convenient premixing of spray
- **Pressure adjustable, air driven spray delivery pump:** to optimize spray delivery

ADVANTAGES

The SmartSPRAY system automates teat spraying to save time and labour.



Sprays every cow, every time
Reduces labour in the parlour while ensuring maximum coverage and optimum teat condition



Easier spraying, easier cupping
The spray system also acts as a leg spreader to make cupping easier



Pre-milking option
A pre-milking spray option is available (only with DairyHQ™ Dairy Management) which reduces labour



Bullet also works as a leg spreader to make cupping more effective



WALKOVERSPRAYER

Improve your teat spraying accuracy and reliability with the WalkoverSPRAYER's intelligent sensor technology.



THE AUTOMATIC TEAT SPRAYING SYSTEM TO ENSURE ACCURACY, EFFICIENCY & RELIABILITY

The WalkoverSPRAYER has been designed for herringbone and parallel dairies to accurately teat spray cows as they enter or exit the milking parlour to improve your efficiency and spray efficacy.

The system identifies individual cows and automatically adjusts the spray timing based on cow speed, to ensure accurate spray coverage regardless of how fast the cow is moving over the unit.

At a normal walking pace the WalkoverSPRAYER automatically deploys two spray nozzles to accurately spray all four teats, and deploys all four nozzles if the cows are moving faster.

The WalkoverSPRAYER suits small, medium and large-size dairies and solid panels can be fitted to the yard rails on each side of the unit to help prevent spray drift if the system will be located in a windy environment.

What's Included:

- **Sprayer unit:** With no moving parts, maintenance is reduced and ensures reliability and longevity.
- **Controller unit:** PCB Controller with push button adjustment.
- **Sensor:** Detects the cow and automatically deploys two or four spray nozzles depending on the speed of the cow through the raceway.



ADVANTAGES

The WalkoverSPRAYER uses intelligent sensor technology to ensure excellent coverage, every time.



Optical sensor technology for accurate coverage

Automatically deploys two or four spray nozzles according to the speed of the cows entering or exiting the milking parlour.



Automatic nozzle wash function

Reduces teat spray build-up and ensures that the nozzles are always clean and clear of contaminants.



Robust construction

Engineered from stainless steel with no moving parts for durability, reliability, longevity and performance.



WAIKATO SPRAY ARM

Automate your pre and post spraying routine for your rotary parlour, reducing labour costs.

ACCURATE AND RELIABLE, SAVING LABOUR COSTS

The Waikato Spray Arm is a game changing automatic teat spraying system for large fast-moving rotaries.

The Waikato Spray Arm system allows for pre-spray and/or post-spray units to be installed, removing expensive labor units from your operation.

A series of advanced sensors accurately locate the cows position on the platform as she nears the exit / entry areas. This information is then communicated directly to the controller. The stall sensors determine the direction of the platform, measures the speed and activates a spray sequence. The cow sensor detects if there is a cow in the stall. No cow, no spray, no waste.

Thorough teat spray coverage of all four teats is achieved with the use of two independently controlled spray nozzles in each arm, that extend under the cows' udder as the rotary platform passes. The Spray Arm Controller can easily adjust the sequencing and spray volumes to suit your requirements.

Models available:

- **Waikato Spray Arm Exact:** Single spray arm mounted on a stationary pole. Sprays each stall as it passes. Suitable for 78 point and below. For speeds as fast as 5.5sec/stall.
- **Waikato Spray Arm Rapid Dual:** Two spray arms mounted on a stationary pole. Sprays each stall as it passes. Suitable for 80 points and above. For speeds as fast as 3.8sec/stall.

What's Included:

- **Spray Arm Exact:** Waikato Spray Arm, Touchscreen controller, teat spray pump, 24V DC power supply, sensors, brackets to mount the arms.
- **Spray Arm Rapid:** 2x Waikato Spray Arms, Touchscreen controller, teat spray pump, 24V DC power supply, sensors, slide assembly and mounting frame.

ADVANTAGES

The Waikato Spray Arm uses advanced sensor technology to ensure accurate spraying coverage, every time.



Easy to install

Easy to install and inexpensive to maintain.



Reliable and precise spray pattern.

Advanced sensors accurately locate the cow.



Affordable Automation

For large, fast moving rotaries.

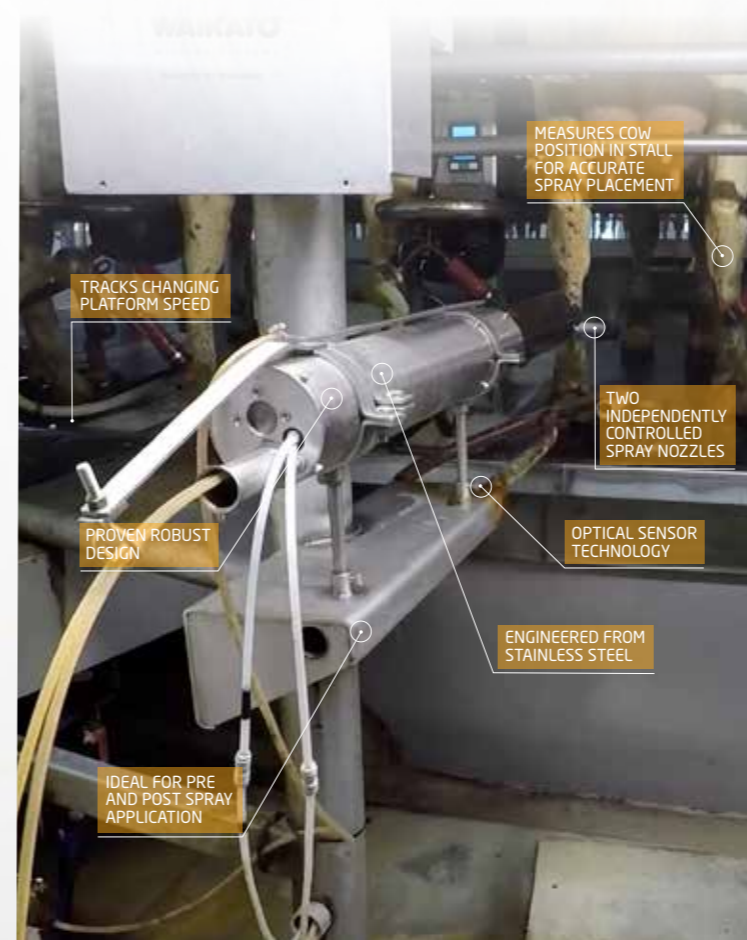

TRACKS CHANGING PLATFORM SPEED

MEASURES COW POSITION IN STALL FOR ACCURATE SPRAY PLACEMENT

TWO INDEPENDENTLY CONTROLLED SPRAY NOZZLES

PROVEN ROBUST DESIGN

OPTICAL SENSOR TECHNOLOGY

ENGINEERED FROM STAINLESS STEEL

IDEAL FOR PRE AND POST SPRAY APPLICATION

SORT GATE 2500

Sort your animals at the end of milking with the economical, entry-level Sort Gate 2500.



THE LOW COST, HIGHLY RELIABLE SORTING SYSTEM

This entry-level 3-way sorting gate will give you good drafting accuracy and value for money.

The gate control utilises RF identification via either a flat panel antenna for eartag or a stainless hoop antenna for integrated collar ID. The antenna controller sends the RFID to the parlour management system and will draft the animal if required.

The gate control system is built with high quality animal detection sensors and robust and reliable pneumatic components which are mounted safely out of harm's way above the gate. The gate controller integrates seamlessly with DairyHQ™ parlour management or CowTRAQ™ Collars.

If CowTRAQ™ collars are installed, then automatic drafting of on-heat animals will give you peace of mind during the busy mating season.

ADVANTAGES

The Sort Gate 2500 is a cost-effective and reliable entry-level sorting system.



Three-way sorting gates

Utilises a pneumatic system to open and close quietly, promoting good cow flow.



Animal identification sensors

Features animal ID sensors built into the panels to automatically activate the gate.



Low cost & reliable

An economical solution to reduce your workload in the parlour with reliable sorting.



SORT GATE 2600

Sort your animals accurately and enhance your cow flow, with the mid-level Sort Gate 2600.



INCREASED ACCURACY, WITH BETTER COW FLOW

With an additional set of stop gates, the accuracy of your sorting, significantly increases with the Sort Gate 2600, by creating a gap between the animals.

If the first cow in the gate is to be sorted but is hesitating to move into the sorting yard, the stop gates will prevent the second cow from pushing through and being inadvertently sorted. Similarly, if the first cow is going straight through and the second cow is to be sorted, the stop gates will detain the second animal until the first is clear of the sort gates, then activate the gates and allow the second cow to sort.

The Sort Gate 2600 also integrates seamlessly with DairyHQ™ parlour management and CowTRAQ™ Collars. Containing high quality sensors, electronics and pneumatics, the Sort Gate 2600 is also constructed from long lasting and robust galvanised steel.

ADVANTAGES

The Sort Gate 2600 is a mid-level sorting system with enhanced animal flow control.



Two sets of gates

Provides more control over your animals as they move through the sort gate.



Double-acting, fast opening gates

Provides more room for cows to turn, and better cow flow to the correct sort area.



Seamless integration

Integration is seamless with DairyHQ™ parlour management and CowTRAQ™ Collars.



SORT GATE 5500

Sort your larger cow breeds accurately, with the robust and durable premium-level Sort Gate 5500.



THE STRONGER SORTING SYSTEM FOR LARGER COWS

The Sort Gate 5500 is our flagship, premium-level, fully featured system for sorting large cow breeds on larger-scale dairy farms while giving you the reliability, durability, accuracy and quality you're looking for.

The heavy-duty frame on the Sort Gate 5500, better serves both larger animals and large-scale 24/7 farming operations. The double acting sort gates allow for increased opening speed to catch faster moving animals, increasing sorting accuracy.

A wider opening gap reduces the turning angle for a sorted cow, thereby improving cow flow. The Sort Gate 5500 also has the option of a roof over the gate for increased cow comfort and reduced exposure of control components to the elements.

The use of high-quality sensors, electronics, and pneumatics ensures longevity.

ADVANTAGES

The Sort Gate 5500 is a premium-level sorting system for larger breed animals.



Designed for larger animals
Heavy duty frames suit larger cows, and large-scale dairy farms.



Durable and robust
Constructed from heavy-duty galvanised steel for strength and durability.



Double-acting, fast opening gates
Provides more room for cows to turn, and better cow flow to the correct sort area.

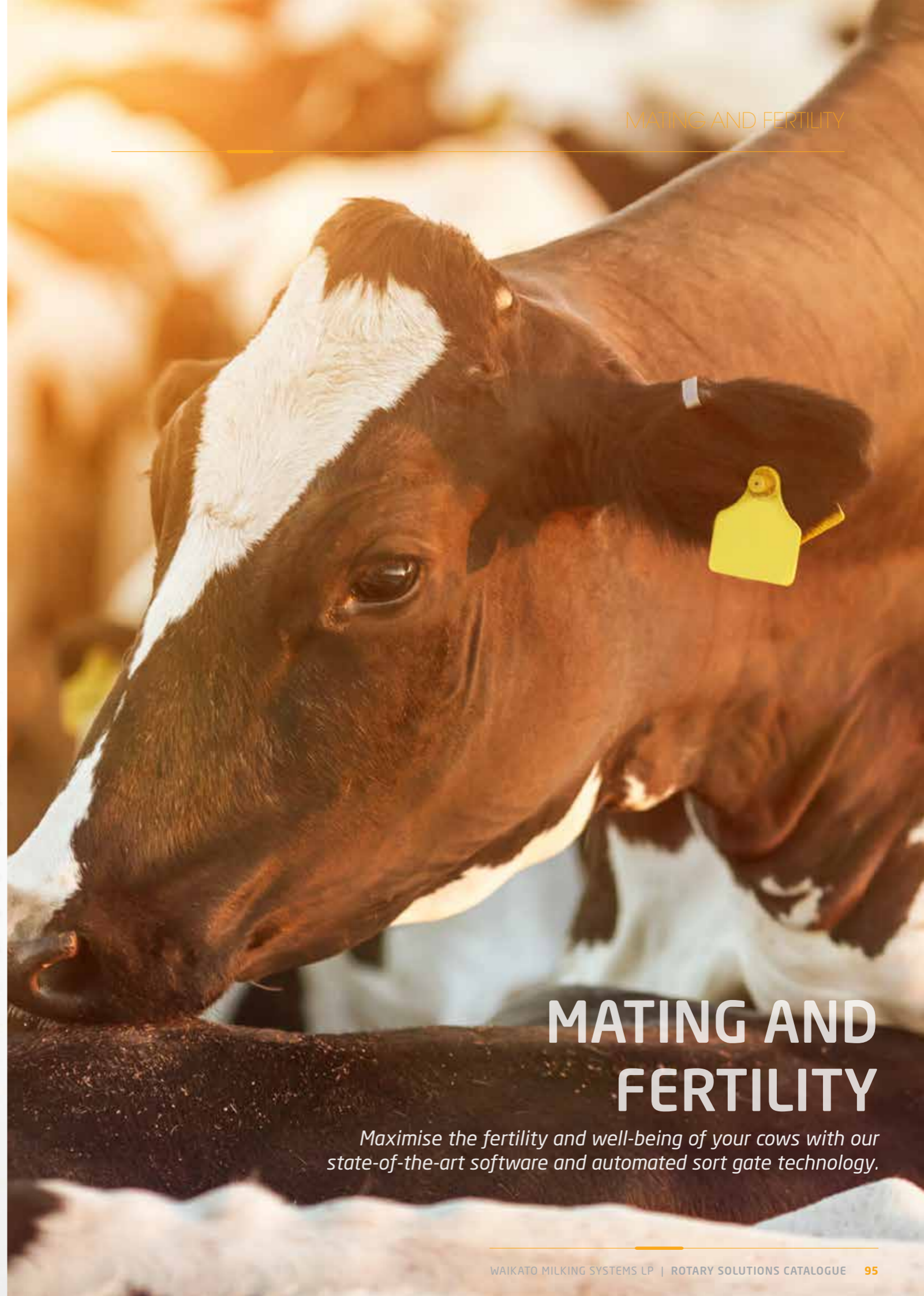

MATING AND FERTILITY

Maximise the fertility and well-being of your cows with our state-of-the-art software and automated sort gate technology.

COWTRAQ™ COLLARS

Maximise your herd performance and farm efficiency with 24/7 heat and health monitoring for every cow.



KEEP YOUR HERD'S PERFORMANCE AND FARM EFFICIENCY ON TRACK

CowTRAQ™ collars provide 24/7 heat and health monitoring for every cow to maximise herd performance and farm efficiency.

CowTRAQ™ collars integrates with TracHQ™ software to provide you with real-time information and mobile alerts in a simple, user-friendly format. CowTRAQ™ collars identify each cow and keep track of her signs of heat, eating, rumination, standing, lying, walking and inactive behaviour 24/7 to provide you with insights on the fertility, health, well-being and nutritional status of individual cows and groups. TracHQ™ software provides you with real-time and relevant alerts, actionable to-do lists and reports to help you track, manage and control your herd. These data-driven decisions enable you to improve your farm management at a tactical and strategic level to improve your herd's performance, and ultimately, your bottom line.

What's Included:

- **Antenna:** The data from all the individual cows is continuously collected by the antenna. The short antenna has a range of at least 75 meters around the barn and the long antenna gives 250 meters when placed outside for grazing cows.
- **Processing unit:** The processing unit processes the data received by the antenna, analyses the individual data for each cow and turns it into relevant and actionable insights that can be viewed on PC, tablet and smartphone.
- **Cloud:** A continuously expanding range of services such as online backup, remote access, remote support and more are available through the cloud.
- **TracHQ Software:** Waikato Milking Systems TracHQ™ combines an unmatched range of monitoring features and management tools in a highly advanced, yet easy to use system including, health monitoring, heat detection, herd performance trends and identification.



ADVANTAGES

CowTRAQ™ collars and TracHQ™ software maximises your herd performance and farm efficiency 24/7.



Targeted management and optimisation

The system provides monitoring and tools for targeted management, precision feeding and labour efficiency.



Accurate heat detection

Improves reproduction results and increases labour efficiency by automatically tracking signs of heat.



Individual cow health monitoring

Detects health issues and metabolic disorders early to keep cows healthy and reduce veterinary treatment.



COWTRAQ™ COLLARS *continued...*

Maximise your herd performance and farm efficiency with 24/7 heat and health monitoring for every cow.

24/7 COW MANAGEMENT | ALL-IN-ONE

Waikato Milking Systems TracHQ™ software combines an unmatched range of monitoring features and management tools in a highly advanced, yet easy to use system.

Real-time information on all devices for multiple users

All team members have access to real-time and relevant insights, at any time and from anywhere with a PC, tablet or smartphone.



Identification*

Proven electronic ISO compliant cow identification in all your automated systems such as milking, feeding and sorting & routing equipment.

* Depends on whether the herd has RFID Ear Tags



Health Monitoring

Individual health management for early detection of health issues and intensive monitoring of transition cows and post-treatment recovery.



Heat Detection

Highly accurate heat detection with advice for the optimal insemination moment, as well as reproduction insights.



Herd Performance Trends

Chart the behaviour patterns of your groups and entire herd. Get group alerts when possible risks affect a group's performance. Evaluate the impact of management decisions on herd performance to make improvements.



Integration & Connection

Easily connect to Waikato Milking Systems DairyHQ™ Parlour Management System for a complete range of milking point controls, milk indicators, milk meters and milk analytical sensors.

ACTIONABLE HERD INSIGHTS REAL-TIME

The right information at the right time for the right person. Anytime and anywhere. A user friendly presentation of relevant information about individual cows and groups.

Dashboard

Widget-based overview of the most important alerts, to-do lists and reports.

Heat detections

Worklist of cows in heat, including advice on their optimal insemination moment for effective insemination with the highest chance of conception and additional reproduction insights.

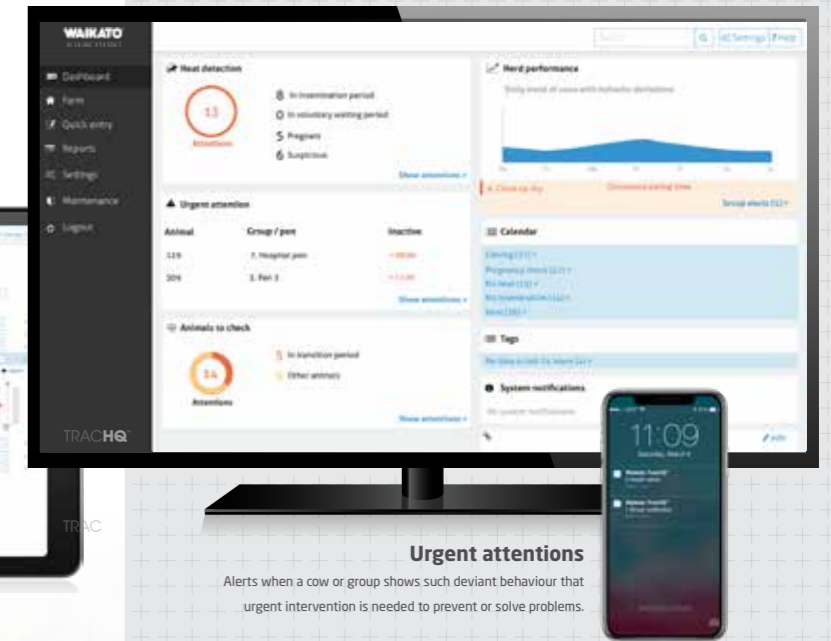
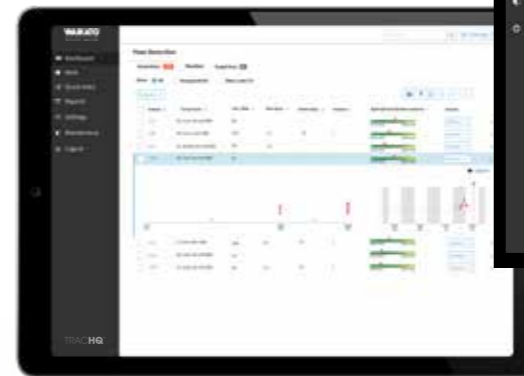

Urgent attentions

Alerts when a cow or group shows such deviant behaviour that urgent intervention is needed to prevent or solve problems.



Animals to check

Worklist of animals to check including report of their deviant behavior that provides insight into possible health issues of each cow on the list.



Health Monitoring

- 48-hour report showing complete time spent of a cow across all activities.
- 60 day reports showing her day totals per activity including group benchmark.

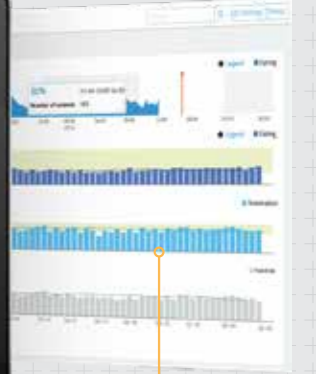

Herd Performance Trends

- Group Eating Pattern: 48-hour report showing the percentage of all cows in a group eating simultaneously.
- 60 day reports showing her day totals per activity including herd benchmark.

TRACHQ™ SOFTWARE

Track your herd in real-time to maximise your herd performance and farm efficiency.

KEEP YOUR HERD'S PERFORMANCE ON TRACK



Waikato Milking Systems TrachQ™ provides you with insights on every cow so you can maximise your herd performance and farm efficiency by providing real-time information and mobile alerts in a simple, user-friendly format.

TrachQ™ turns data from CowTRAQ™ collars into relevant and real-time alerts, to-do lists, reports and barn maps to help manage and control your herd.

These easy to understand and actionable insights are delivered directly to your PC, tablet or smartphone.

TrachQ™ allows you to make data-driven decisions and improve your farm management at a tactical and strategic level using the behavioural insights of individual cows and the entire herd.

Health monitoring information allows you to automatically focus on the right cows, at the right time, with the right treatment to keep them healthy, fertile and productive.

What's Included:

- The TrachQ™ Software is an **HTML5 web application** viewable on any of your internet-ready devices.
- The **software license** is included with the purchase of your collar equipment.
- Note: **TrachQ™ Antenna** and **controller hardware** is required to receive collar data

ADVANTAGES

Waikato Milking Systems TrachQ™ provides insights to maximise your herd performance and farm efficiency.



User-friendly, actionable herd insights

Heat detections, urgent attentions, animals to check, health monitoring & herd performance trends.



Make data-driven decisions

Monitor production for targeted management, and optimise production through precision feeding.



Real-time information for multiple users

All team members have access to relevant insights at any time, from any device.

Dashboard

Widget-based overview of the most important alerts, to-do lists and reports.

Heat detections

Worklist of cows in heat, including advice on their optimal insemination moment for effective insemination with the highest chance of conception and additional reproduction insights.



Urgent attentions

Alerts when a cow or group shows such deviant behaviour that urgent intervention is needed to prevent or solve problems.



HEAT DETECTION

Improve reproduction results, increase labour efficiency.

TrachQ™ detects heats with outstanding accuracy, helping dairy farmers worldwide improve reproduction results and labour efficiency. It automatically tracks the signs of heat - such as increased activity, sniffing, chin resting and mounting behaviour - of all your cows, 24 hours a day. The system shows a clear list of all cows in heat with their optimal insemination moment for effective insemination with the highest chance of conception. It also provides additional reproduction insights, helping you to find cows with irregular heats, non-cycling cows and non-pregnant cows.



HERD PERFORMANCE TRENDS

Evaluate group and herd behaviour, improve farm management.

TrachQ™ charts the behaviour patterns of your groups and entire herd. They show you how external factors and management decisions influence the herd's performance. The system sends a group alert when it detects abnormalities among a percentage of the cows in a group, allowing you to respond to external factors posing a risk to their health, milk production and reproduction. At strategic level, group behaviour reports on herd performance insights offering a valuable tool to measure and evaluate the impact of (changed) feeding strategies, housing conditions, grazing and milking procedures. So you have fact-based information to continuously optimise your management and improve your bottom line.

TRACHQ™ SOFTWARE *continued...*

Track your herd in real-time to maximise your herd performance and farm efficiency.

THE RIGHT INFORMATION AT THE RIGHT TIME

...for the right person. Anytime and anywhere.

Animals to check

Worklist of animals to check including report of deviant behaviour that provides insight into possible health issues of each cow on the list.

Health Monitoring

- 48-hour report showing complete time spent of a cow across all activities.
- 60 day reports showing her day totals per activity including group benchmark.

Herd Performance Trends

- Group Eating Pattern: 48-hour report showing the percentage of all cows in a group eating simultaneously.
- 60 day group reports showing day totals per activity including herd benchmark.

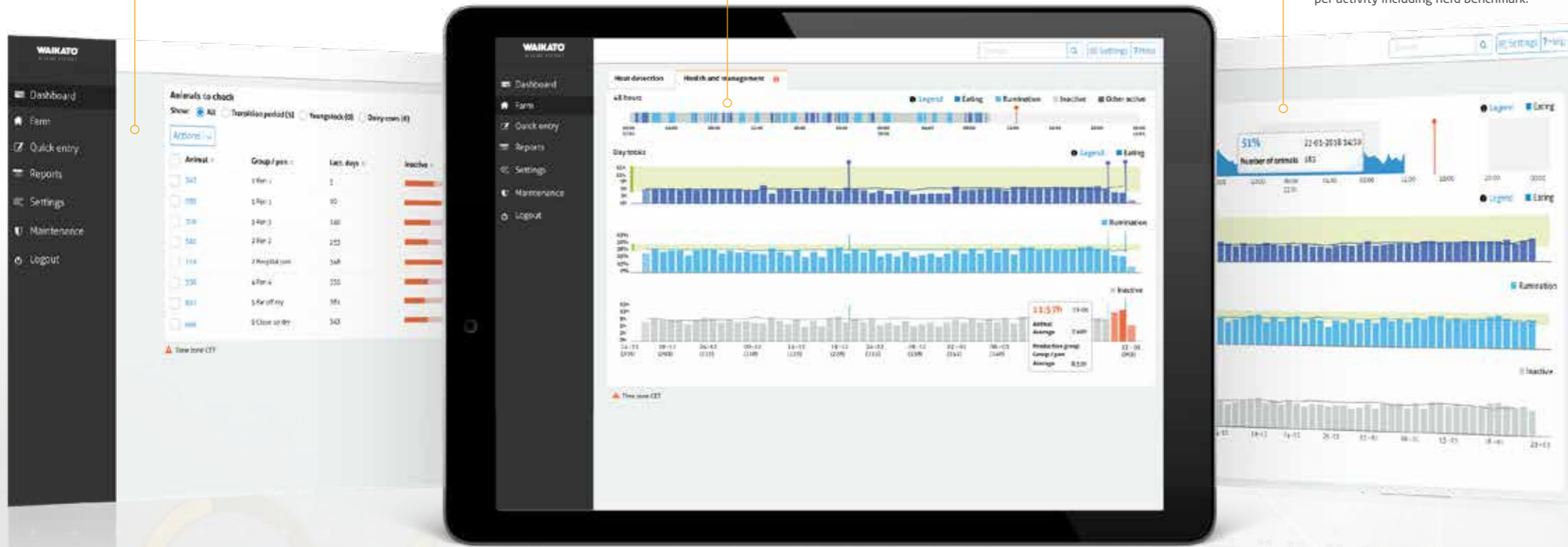

HEALTH MONITORING

Keep cows healthy, fertile and productive

TrachQ™ Health Monitoring is an essential tool to keep your cows healthy, fertile and productive. CowTraQ™ Collars register a combination of three behavioral aspects, giving the most precise and complete insight into the health status of each cow. The system compares all behaviour with standards for optimum condition, the previous behaviour of the cow and the behaviour of the group she is in and detects changes or abnormalities. It provides the earliest and most reliable health alerts for cows that need urgent attention and shows a list of cows that need to be checked today, allowing you to treat health issues before they become problems. It also enables you to intensively monitor transition cows and post-treatment recovery.

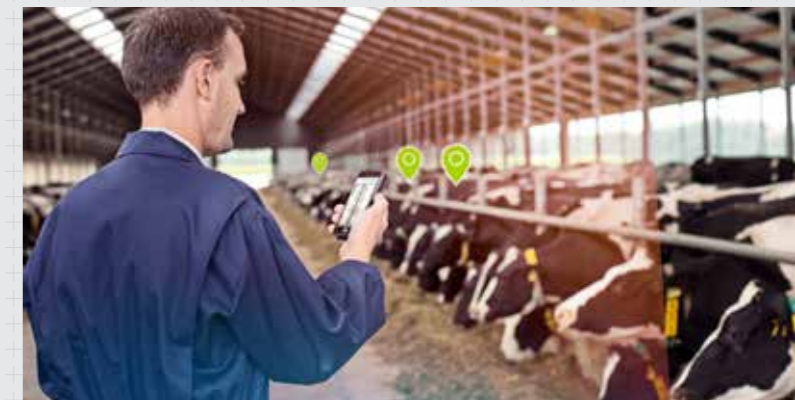

COW LOCATION (USA AND EUROPE ONLY)

Stop searching, start finding.

Finding cows needing to be checked, inseminated, treated or fetched, was never as easy and time-saving as it is with TrachQ™ Cow Location. The system automatically locates the cows you need to find. It accurately shows and follows the real-time position of individual or multiple cows on your barn map with one click on your PC, tablet or smartphone. TrachQ™ Cow Location is fully integrated with Heat Detection, Health Monitoring and Herd Performance Trends. As a result, responding to cows that need attention is easier and quicker than ever. This saves you and your team a lot of time and aggravation every day and at the same time ensures a better follow-up of alerts.

WHERE DO YOU WANT TO IMPROVE?

- Improve Reproduction Results?
- Better cow health and condition?
- Improve farm management?
- Get a more productive and sustainable herd?
- Increase labour efficiency and effectiveness?
- Save costs?
- Improve welfare and sustainable production?
- More enjoyable work?

SORT GATE 2500

Sort your animals at the end of milking with the economical, entry-level Sort Gate 2500.



THE LOW COST, HIGHLY RELIABLE SORTING SYSTEM

This entry-level 3-way sorting gate will give you good drafting accuracy and value for money.

The gate control utilises RF identification via either a flat panel antenna for eartag or a stainless hoop antenna for integrated collar ID. The antenna controller sends the RFID to the parlour management system and will draft the animal if required.

The gate control system is built with high quality animal detection sensors and robust and reliable pneumatic components which are mounted safely out of harm's way above the gate. The gate controller integrates seamlessly with DairyHQ™ parlour management or CowTRAQ™ Collars.

If CowTRAQ™ collars are installed, then automatic drafting of on-heat animals will give you peace of mind during the busy mating season.

The Sort Gate 2500 is a cost-effective and reliable entry-level sorting system.



Three-way sorting gates

Utilises a pneumatic system to open and close quietly, promoting good cow flow.



Animal identification sensors

Features animal ID sensors built into the panels to automatically activate the gate.



Low cost & reliable

An economical solution to reduce your workload in the parlour with reliable sorting.



SORT GATE 2600

Sort your animals accurately and enhance your cow flow, with the mid-level Sort Gate 2600.



INCREASED ACCURACY, WITH BETTER COW FLOW

With an additional set of stop gates, the accuracy of your sorting, significantly increases with the Sort Gate 2600, by creating a gap between the animals.

If the first cow in the gate is to be sorted but is hesitating to move into the sorting yard, the stop gates will prevent the second cow from pushing through and being inadvertently sorted. Similarly, if the first cow is going straight through and the second cow is to be sorted, the stop gates will detain the second animal until the first is clear of the sort gates, then activate the gates and allow the second cow to sort.

The Sort Gate 2600 also integrates seamlessly with DairyHQ™ parlour management and CowTRAQ™ Collars. Containing high quality sensors, electronics and pneumatics, the Sort Gate 2600 is also constructed from long lasting and robust galvanised steel.

ADVANTAGES

The Sort Gate 2600 is a mid-level sorting system with enhanced animal flow control.



Two sets of gates

Provides more control over your animals as they move through the sort gate.



Double-acting, fast opening gates

Provides more room for cows to turn, and better cow flow to the correct sort area.



Seamless integration

Integration is seamless with DairyHQ™ parlour management and CowTRAQ™ Collars.



SORT GATE 5500

Sort your larger cow breeds accurately, with the robust and durable premium-level Sort Gate 5500.

THE STRONGER SORTING SYSTEM FOR LARGER COWS

The Sort Gate 5500 is our flagship, premium-level, fully featured system for sorting large cow breeds on larger-scale dairy farms while giving you the reliability, durability, accuracy and quality you're looking for.

The heavy-duty frame on the Sort Gate 5500, better serves both larger animals and large-scale 24/7 farming operations. The double acting sort gates allow for increased opening speed to catch faster moving animals, increasing sorting accuracy.

A wider opening gap reduces the turning angle for a sorted cow, thereby improving cow flow. The Sort Gate 5500 also has the option of a roof over the gate for increased cow comfort and reduced exposure of control components to the elements.

The use of high-quality sensors, electronics, and pneumatics ensures longevity.



ADVANTAGES

The Sort Gate 5500 is a premium-level sorting system for larger breed animals.



Designed for larger animals
Heavy duty frames suit larger cows, and large-scale dairy farms.



Durable and robust
Constructed from heavy-duty galvanised steel for strength and durability.



Double-acting, fast opening gates
Provides more room for cows to turn, and better cow flow to the correct sort area.

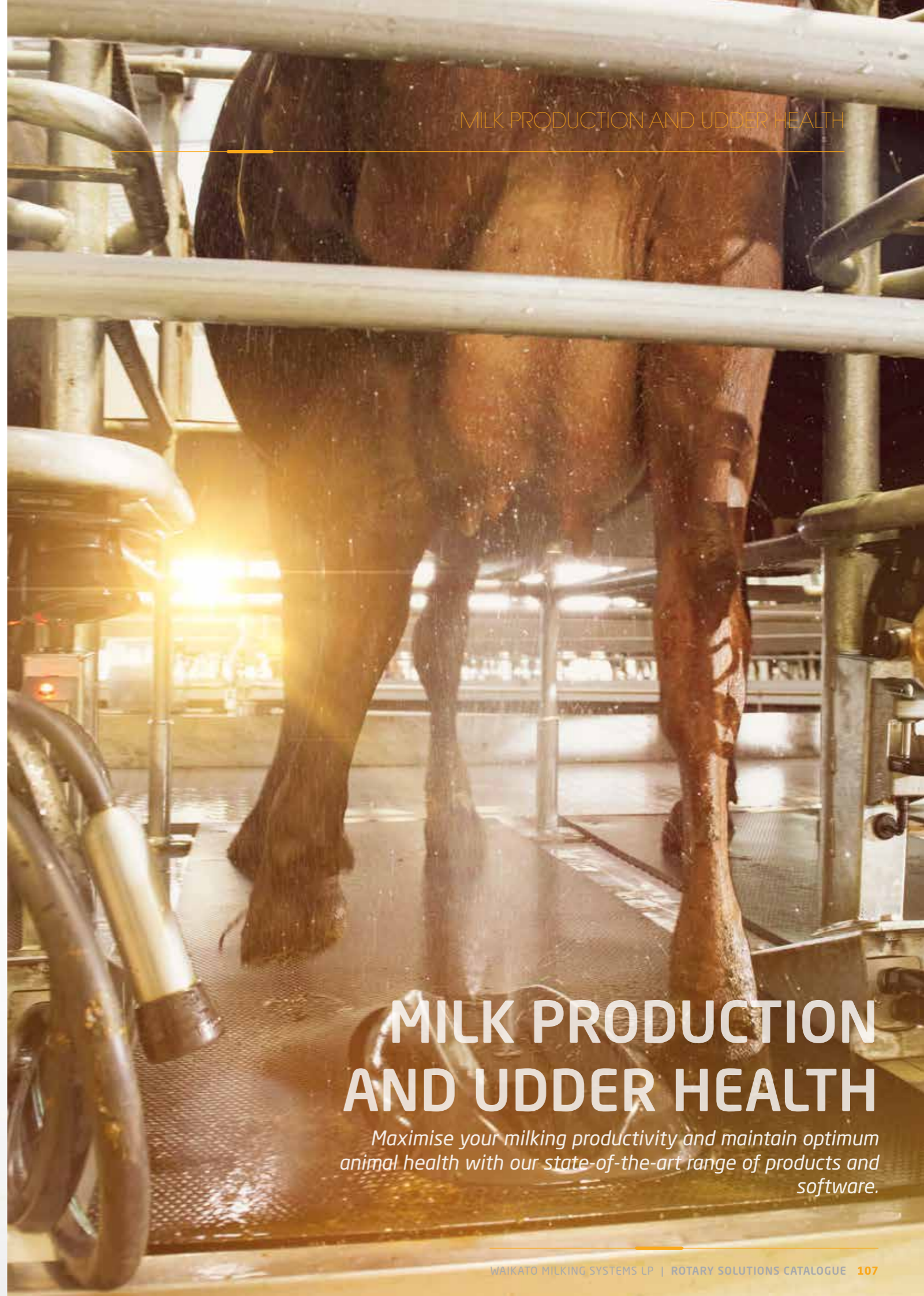

MILK PRODUCTION AND UDDER HEALTH

Maximise your milking productivity and maintain optimum animal health with our state-of-the-art range of products and software.

ELECTRONIC MILK METER

Real-time milking data to monitor and improve your herd's productivity and performance.

MONITOR YOUR MILKING PERFORMANCE, IN REAL-TIME.

The Waikato Electronic Milk Meter provides you with real-time information on the performance of your cows to deliver an accurate and clear picture of how each animal is performing, at every milking.

By supplying you with valuable data on milk yield, flow rates and milking duration in addition to milking volume, the Electronic Milk Meter provides a milking profile of each animal to show how she milks. This can be an indicator of milking procedure performance and cow comfort. This data allows you to make important herd management decisions including feed regimes for each animal, breeding and possible veterinary actions to ensure your entire herd is performing to its optimum level. Simplicity is at the heart of our design philosophy. That's why we've made the Electronic Milk Meter easy to disassemble without the need for tools. The screw cap can be unwound and the lid of the meter lifts off to provide access to the meter's centre and outer chamber, its sensing pins and breather snorkel. The cylindrical design of the meter ensures thorough cleaning as wash water "dead zones" are eliminated. During plant washing, timed pulses of air are admitted into the meter body to create turbulence and ensure a pristine clean every time.

What's Included:

- Hard wearing polymer flask
- Stainless Steel mounting bracket:
- Pre-terminated connection cable: for communication with the Bail Marshal
- Built in spirit level: to ensure accurate installation

ADVANTAGES

The Electronic Milk Meter provides real-time information on the performance of your cows.



High accuracy metering

Highly accurate milking data you can rely on to make important herd management decisions.



Claw vacuum stability

Designed to suit high flow rate milking while maintaining stable teat end vacuum.



Monitor every animal, every milking

Know exactly how each animal is performing at every milking.

An optional User Display provides the operator with exact status of each animal and any alerts that may have occurred.



YIELD INDICATOR

Improve your herd management decisions by monitoring every animal's milking performance.

THE COST-EFFECTIVE WAY TO MEASURE MILK VOLUME.

The Waikato Milking Systems Yield Indicator is a cost-effective unit that measures your milk volume with an accuracy of +/- 10%, allowing you to monitor every animal's milking performance to improve your herd management decisions.

The Yield Indicator works in conjunction with the milking point controller, by counting and timing milk slugs across the internal probes. Featuring no moving parts and a single long-life gasket, the robust design of the Yield Indicator ensures reliability with low maintenance and operational costs.

The unit's ingress protection (IP) makes it suitable for use within all milking parlour environments.

By providing you with milk volume data, the Yield Indicator allows you to understand which animals are the highest and lowest performers so you can make more informed management decisions - at an entry level price.

What's Included:

- Stainless steel mounting bracket: for connection to your milking parlour
- M8 IP68 plug-in cable set: to suit installation

ADVANTAGES

The Waikato Milking Systems Yield Indicator is the cost-effective way to monitor every animal's milking performance.



Suitable for all milking parlour environments

Options available for cows (high flow) and sheep/goats (low flow), and can be used in both low line and high line milking parlours.



Easy to install, built to last

Featuring quality components (glass filled nylon polymer with a stainless steel bracket) for durability and reliability.



Individual animal yield recording

When combined with a suitable milking point controller, every animal's milking performance can be monitored.

3 models available:

YI2500 Standard yield
Suits 19mm milk lines
Suits most bovine parlours

YI2500XL For high flow applications
Suits 22mm milk lines

YI2500SR Suitable for small ruminant milking
(Sheep and Goat)



320 STANDARD MILKING CLUSTER

An entry-level milking cluster designed to optimise the milk harvesting process.



OPTIMISE YOUR MILK HARVESTING PROCESS WITH AN INDUSTRY PROVEN CLUSTER

The 320 Standard Cluster is an entry-level cluster that has been well proven in the market place for many years.

The Waikato Milking Systems' Standard Milking Cluster provides even milk extraction from each quarter for faster, more efficient milking.

Featuring large bore inlets and outlets to improve milk flow and evacuation, while ensuring a stable milking environment. The robust design of the Standard Milking Cluster optimises the milk harvesting process with a lower entry price.

ADVANTAGES

The Standard Milking Cluster provides optimised milk extraction.



Optimise your milk harvesting
Achieving even extraction from each quarter, faster, this ensures a more efficient milking.



High performance cluster
With stainless steel tops, suitable for large bore liners, the 320 Standard Milking Cluster, gives you the performance you need



Five year Claw warranty
The 320 Standard Milking Cluster offers a 5 year warranty on the Claw bowl, giving you peace of mind.



320 HIGH PERFORMANCE CLUSTER

Ergonomically designed for an all round better, more efficient milking.

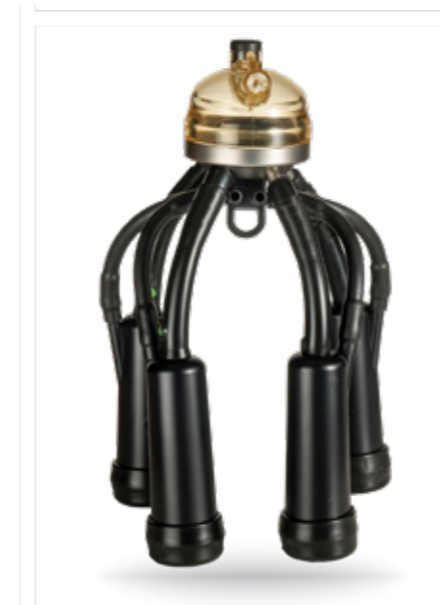

ERGONOMICALLY DESIGNED FOR OPTIMUM FIT AND ANIMAL COMFORT

The 320HP Milking Cluster has been designed to provide a reduced cluster weight, minimising operator fatigue. Teat condition and udder health is improved for teats of all sizes.

The perfect fit of the vented liner provides you with unsurpassed milk extraction and even milk flow from all quarters. The vented liner improves vacuum stability at high milk flow rates.

The unique design of the claw conforms to the latest cow genetics, with narrow rear inlets to improve cluster alignment and milk flow through the teat canal and high-capacity 5/8" and 3/4" outlet versions to effectively and efficiently move milk away from the teat end during liner closure. With its robust, lightweight and ergonomic design, the 320 High Performance Milking Cluster allows the vacuum, pulsation, liner, and the milking unit to work together to optimise the milk harvesting process.

ADVANTAGES

The 320 High Performance Milking Cluster allows you to achieve the fastest milking speed possible, for maximum efficiency.



Ergonomically designed
Provides the optimum fit for cows of varying udder shapes and sizes, and easy handling for operators of all hand-sizes.



Reduces repetitive strain injuries
The 320HP Milking Cluster is super lightweight, significantly reducing the operator's risk of repetitive strain injuries (RSI)



25% lighter cluster design
Weights only 1.3kg (2.86 lb) with a 320ml (10.82fl.oz) claw bowl and comes with a 5 year unconditional bowl warranty



SMARTSPRAY AUTOMATED TEAT SPRAYING

Automated teat spraying that reduces your labour and increases your efficiency.

MAXIMUM TEAT COVERAGE, WITH MINIMAL LABOUR

SmartSPRAY is an innovative automatic teat spray system designed specifically for rotary dairies, that replaces the need for manual teat spraying and teat dipping before and after milking.

With no operator input required during milking, SmartSPRAY greatly reduces labour while ensuring maximum coverage regardless of the cow's position in the bail. The spray nozzles on the bullets can be rotated to cater for a wide variety of cow sizes and different breeds. The bullets are easy to clean and made of durable material designed to withstand years of harsh treatment under the cows at milking time.

The SmartSPRAY system is controlled directly by Waikato ECR-S or ECR Plus cup removers. When combined with Waikato Milking Systems cup removers, SmartSPRAY can be set so it doesn't spray animals that are returning to the operator.

It's possible to fit the SmartSPRAY to other rotary systems using an interface to connect with other types of cup removers.

What's Included:

- **2 or 4 spray nozzles:** built into the Bullet leg spreader (per stall), 2 nozzles are standard, 4 are used for pre & post spraying
- **Electronic solenoid valve:** for accurate volume dispensing
- **On platform chemical storage vessel**
- **Off platform Chemical mixing vessel:** for safe and convenient premixing of spray
- **Pressure adjustable, air driven spray delivery pump:** to optimize spray delivery

ADVANTAGES

The SmartSPRAY system automates teat spraying to save time and labour.



Sprays every cow, every time
Reduces labour in the parlour while ensuring maximum coverage and optimum teat condition



Easier spraying, easier cupping
The spray system also acts as a leg spreader to make cupping easier



Pre-milking option
A pre-milking spray option is available (only with DairyHQ™ Dairy Management) which reduces labour

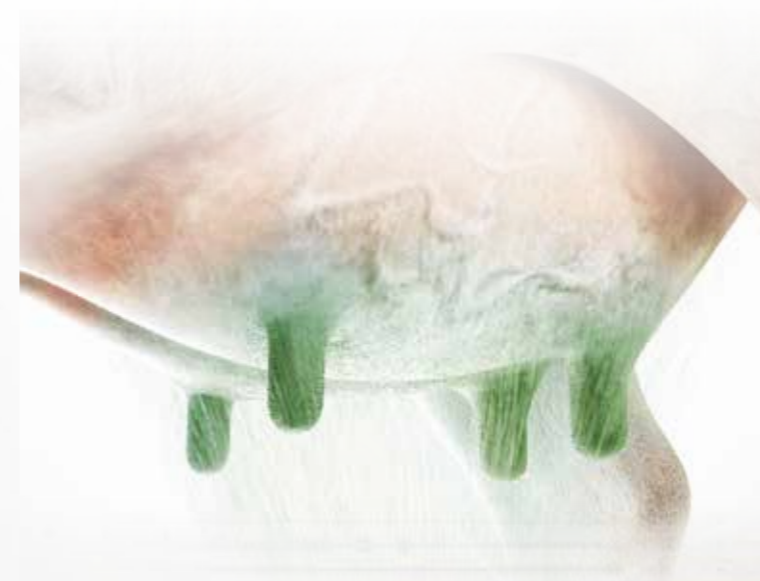

Bullet also works as a leg spreader to make cupping more effective



WALKOVERSPRAYER

Improve your teat spraying accuracy and reliability with the WalkoverSPRAYER's intelligent sensor technology.



THE AUTOMATIC TEAT SPRAYING SYSTEM TO ENSURE ACCURACY, EFFICIENCY & RELIABILITY

The WalkoverSPRAYER has been designed for herringbone and parallel dairies to accurately teat spray cows as they enter or exit the milking parlour to improve your efficiency and spray efficacy.

The system identifies individual cows and automatically adjusts the spray timing based on cow speed, to ensure accurate spray coverage regardless of how fast the cow is moving over the unit.

At a normal walking pace the WalkoverSPRAYER automatically deploys two spray nozzles to accurately spray all four teats, and deploys all four nozzles if the cows are moving faster.

The WalkoverSPRAYER suits small, medium and large-size dairies and solid panels can be fitted to the yard rails on each side of the unit to help prevent spray drift if the system will be located in a windy environment.

What's Included:

- **Sprayer unit:** With no moving parts, maintenance is reduced and ensures reliability and longevity.
- **Controller unit:** PCB Controller with push button adjustment.
- **Sensor:** Detects the cow and automatically deploys two or four spray nozzles depending on the speed of the cow through the raceway.



ADVANTAGES

The WalkoverSPRAYER uses intelligent sensor technology to ensure excellent coverage, every time.



Optical sensor technology for accurate coverage

Automatically deploys two or four spray nozzles according to the speed of the cows entering or exiting the milking parlour.



Automatic nozzle wash function

Reduces teat spray build-up and ensures that the nozzles are always clean and clear of contaminants.



Robust construction

Engineered from stainless steel with no moving parts for durability, reliability, longevity and performance.



CAN TRACK FAST MOVING COWS

AUTOMATIC NOZZLE WASH

ENGINEERED FROM STAINLESS STEEL

AUTOMATIC TWO OR FOUR NOZZLE DEPLOYMENT

OPTICAL SENSOR TECHNOLOGY

TOUGH RUBBER MATTING



SMARTD-TECT UDDER HEALTH DETECTION

Reduce your labour and increase your productivity with SmartD-TECTs automation technology.

REDUCE LABOUR. INCREASE PRODUCTIVITY

SmartD-TECT performs a health analysis of each quarter of the udder by automating your pre-milking stimulation and udder health monitoring without adding additional tasks for the operator.

SmartD-TECT allows you to make data-driven decisions for your herd's health reducing the chance of any loss in productivity. The pulsator milks each quarter separately to measure the conductivity of each teat during the pre-milking phase. Individual quarter conductivity allows SmartD-TECT to eliminate issues with dilution between quarters to provide highly accurate alerts for potential health problems. If any quarters are abnormal, an alert is issued up to four days before visual signs appear, providing the opportunity for early treatment intervention. The pre-milking pulsation for quarter testing also promotes a natural let down response from the cows, eliminating precious time normally spent manually stimulating teats to trigger milk flow. By having the same milking routine each time, cows let their milk down faster, more consistently and at a higher average flow rate. By removing the variabilities of operators, SmartD-TECT provides consistency in performance and productivity advantages that no other conventional milking system offers.

What's Included:

- **SmartD-TECT Pulsator:** Controls individual pulsation signals to the cluster allowing each quarter to be milked separately at the start of milking.
- **SmartD-TECT Sensor:** are attached to the milk line at every cluster to measure the conductivity of the milk from each cow. The results are sent to the pulsator for interpretation.
- **SmartD-TECT Controller:** Is a touchscreen interface that controls SmartD-TECT's sensitivity settings.

ADVANTAGES

SmartD-TECT provides peace of mind for a consistent milking routine and the automated detection of problematic animals and potential udder health issues, reducing treatment time and cost.



Udder Health Monitoring

Identify the onset of mastitis up to four days before visual signs are evident to make decisions earlier.



Individual Quarter Testing

The pulsator milks each quarter separately and measures the conductivity of each for a more accurate alert.



Eliminate Forestripping

Automate your milking stimulation and prep routine to reduce labour and increase your productivity.



During the pre-milking phase, SmartD-TECT milks each quarter separately and measures the conductivity



ECR-S ACRs / DETACHERS

Reduce your labour and improve your milking consistency, accuracy and efficiency.



AUTOMATICALLY REMOVE CUPS, AND REDUCE YOUR LABOUR COSTS

The ECR-S is a robust, easy to use and dependable ACR / Detacher that reduces labour, while cleanly, consistently and accurately milking out your herd.

The ECR-S, with an auto-start feature, has been designed to make the milking process quicker and easier for the operator, while accurate flow sensing provides peace of mind that the herd is being milked out correctly every time.

Suitable for all milking machines, the milking parameters can be easily adjusted to suit your farm's requirements via the ECR-S Controller. This ensures all ACR / Detachers are set the same - and milk each animal the same.

In rotary dairies ECR-S can control the Cow Restraints to retain cows for alerts or longer milkings. ECR-S can also control the SmartSPRAY system to teat spray cows at the end of milking, to further reduce labour and improve udder and animal health.



ControlSWITCH works with ECR-S, giving highly visible alerts for operator feedback on cow alerts and machine status

What's Included:

- **ECR-S ram:** Cup remover cylinder and integrated control circuit board. Accurate and reliable milking of your animals
- **EZY-Start as standard:** ECR is started by simply lifting the cluster
- **SmartCONTROL:** Centralised settings and parameter changes. Quickly and easily adjust your milking regime.
- **ControlSWITCH:** solid state switch which provides visible alerts to the operator



ADVANTAGES

ECR-S allows you to milk out your herd quickly, consistency and accurately, while reducing labour.



Centralised control

Global communication from the ECR-S Controller allows the adjustment of milking parameters for all detachers from one place.



Reduces effort and fatigue

The Ezy Pull-Down valve reduces operator fatigue by reducing the effort needed to attach the cluster.



Gentle on the cow and stallwork

The retraction speed adjustment allows for a gentle disconnect from the udder and stops the cluster crashing into stallwork.



Indicates the status of the ECR



ECR PLUS ACRs / DETACHERS

Maximise your milking automation and efficiency, and make the most informed management decisions.

AUTOMATE YOUR MILKING, AND FUTURE-PROOF YOUR MILKING SYSTEMS

The ECR Plus combines the most advanced ACR / Detacher functions with the collection and communication of milking information configured to suit your farms individual requirements.

Designed to be the heart of your milking automation, ECR Plus allows you to add other milking automation devices using our Plug 'n' Play technology to collect important real-time information from your herd. These can include yield, flow rates, milking time, and the ability to control pulsation and measure milk conductivity for udder health issues and display alerts.

The ECR Plus system is designed to integrate with the DairyHQ™ Dairy Management software which enables powerful features including staff alerts for withholding cows as they enter the machine, and identifying abnormal milkings as they occur. The milking data generated by the ECR Plus system and connected devices can also be used within the DairyHQ™ Dairy Management software to make timely and informed decisions for your milking herd.

What's Included:

- **ECR-PLUS ram:** Cup remover cylinder and integrated control circuit board. Accurate and reliable milking of your animals
- **EZY-Start as standard:** ECR Plus is started by simply lifting the cluster
- **DairyHQ™ Control:** Allows for settings and parameter changes from your phone or PC. Can be upgraded to control all aspects of your parlour including Sorting and ID.
- **ControlSWITCH:** touch-activated switch which gives visible alerts to the operator



ControlSWITCH works with ECR-S, giving highly visible alerts for operator feedback on cow alerts and machine status

DairyHQ™ Dairy Management System



ADVANTAGES

ECR Plus maximises milking automation and efficiency, and the collection and communication of your milking information.



Feature-packed automation technology

Includes all features of the ECR-S system plus Claw Drop, Pre-Spray and Fixed Point Take Off



Powerful data management and communication

Seamless integration with our DairyHQ™ Dairy Management System allows for milking alarms and much more



Future-proof your milking system

True Plug 'n' Play technology can be configured to suit your milking requirements today, while allowing for future expansion by simply plugging in new technology



Indicates the status of the ECR



DAIRYHQ™ PARLOUR MANAGEMENT SYSTEM

Drive your milking productivity and performance with intelligent and intuitive dairy management.



THE INTELLIGENCE BEHIND YOUR DAIRY AUTOMATION

The DairyHQ™ Parlour Management System provides you with intelligent and adaptive automation to drive your milking productivity and performance.

The DairyHQ™ Parlour Management System has been designed to provide you with the intelligence to drive your Waikato Milking automation and improve your dairy management, with a simple and intuitive user experience.

The DairyHQ™ CONTROL module allows you to make adjustments and fine tune your milking machine to optimise it for your farm's unique requirements. Each setting has an on-screen explanation to help the user get the most out of their milking machine.

As a modular state-of-the-art software system, new DairyHQ™ modules and features are continually being added allowing you to easily upgrade to improve your productivity and performance further, and stay up-to-date with industry developments.

What's Included:

- **DairyHQ™ application:** The DairyHQ™ web application, supported on a PC, tablet or mobile device that has access to a Google Chrome web browser.
- **DairyHQ™ server:** Secured storage of your DairyHQ™ milking and cow data.
- **SmartLink:** Waikato Milking System's communications gateway device, linking the Waikato Milking products to the DairyHQ™ server.
- **Wi-Fi Router:** Connects your devices to the DairyHQ™ server.



ADVANTAGES

DairyHQ™ CONTROL allows you to take control of your milking machine to drive your milking productivity and performance.



A complete visual overview of your rotary

The system is connected to all key milking components to provide you with real-time insights.



Wireless connectivity

Wireless connectivity allows you to connect to DairyHQ™ CONTROL using almost any phone, tablet or computer.



Modern, easy to use interface

A simple touch-screen interface provides an intuitive user experience, for fast data entry and work routines.



Please see the DairyHQ™ brochure or talk to your local Regional Sales Manager for the latest information on available modules.



DAIRYHQ™ *continued...*

Drive your milking productivity and performance with intelligent and intuitive dairy management.

DAIRY VIEW - A VIEW LIKE NO OTHER

The unique Dairy View feature in DairyHQ™ CONTROL allows you to monitor and view the entire platform with real-time milking alerts and status to indicate potential issues or warnings.

DairyHQ™ CONTROL offers the best of both worlds, integrating a wheel view as well as a list view, creating an interface like no other.

DairyHQ™ has been designed with large buttons and bold type for ease-of-use in a real-world dairy environment. Bring your own device technology (BYOD) allows DairyHQ™ to run on any device with Google Chrome web browser. Access DairyHQ™ anywhere in Wi-Fi range.

TAKE CONTROL OF YOUR MILKING MACHINE WITH DAIRYHQ™

The DairyHQ™ Dairy Management System allows you to make adjustments and fine tune your milking machine to optimise it for your farm's unique requirements - using almost any wireless device.



- **Features include:**
 - Air Sweep Delay
 - Air Sweep Time
 - Fixed Position Take-Off
 - Flow Value Detection
 - Let Down Delay
 - Maximum Milking Time
 - Minimum Milking Time
 - Milk/Wash Mode
 - Retention Bar Delay
 - Sensor Sensitivity
 - Take-Off Delay
 - Auto Cluster Drop Mode
 - Auto Park Delay
 - Auto Park to Idle Delay

MINIMUM MILKING TIME ALERT

MILK METER DRAIN FAIL ALERT

NO MILK DETECTION ALERT



MANUAL MILKING

MILKING MODE IDLE

REAL-TIME MILKING ALERTS WITH DAIRY VIEW

The unique Dairy View feature in DairyHQ™ CONTROL allows you to monitor and view the entire platform with real-time milking alerts and status to indicate potential issues or warnings.

The simple touch-screen interface has been designed with large buttons and bold type for ease-of-use in a real-world dairy environment.

DAIRYHQ™ SORT *continued...*

Improve your dairy operation's efficiency and accuracy.

SORT COWS QUICKLY, ACCURATELY, AND AUTOMATICALLY ... WITH DAIRYHQ™ SORT

As an add-on module to DairyHQ™ Dairy Management System, DairyHQ™ SORT allows you to quickly and accurately sort your animals automatically, according to your specific instructions, with an intuitive and easy-to-use interface.

The DairyHQ™ SORT system incorporates an RFID Antenna that is fitted to a sort gate, which reads the identification tags of each animal as it approaches. With three-way sorting, the gate directs each animal to the left, right or straight ahead moments before the animal approaches the gate - depending on your pre-loaded or updated instructions. The gate operates quickly, quietly and smoothly, providing a calm environment for the animals to be sorted.

ADVANTAGES



REDUCE LABOUR COSTS

DairyHQ™ SORT eliminates the need to manually sort animals, freeing up labour to work on other important farm tasks.



INCREASE EFFICIENCY

By allowing you to automatically identify and sort animals that require attention, or require early health intervention, you can make better long-term decisions for your herd to increase your efficiency and stay ahead of the curve.



ACCURATE SORTING

DairyHQ™ SORT takes the guesswork out of manually identifying and sorting your animals by organising your herd according to your instructions - and allowing you to generate reports to double-check and review your sorting programmes.



USER FRIENDLY

The user-friendly interface features large touch-screen buttons and text areas to provide ease-of-use for operators in any milking environment on a smartphone, tablet, desktop computer, or on a large touch-screen display.



The DairyHQ™ SORT system allows you to:

- Create a sort function to automatically hold selected animals for health reasons, or for culling.
- Schedule animals to be sorted on a specific date and milking session.
- Select specific groups of animals to be sorted.
- Automatically sort animals that present at milking with faulty, or no identification tags, so they can be replaced.
- Sort animals with new identification tags that are not registered with your farm's herd database.
- Detect which animals in your herd were not present at milking time via the sort report.
- Import herd data from third party herd management software systems, or export herd data for other herd management systems.
- Apply a quick sort to a cow using the "Sort ASAP" feature if a cow presents with a problem and needs to be held for inspection at the end of milking - bypassing the need to set a date and reason for the sort.

A RANGE OF REPORTS AVAILABLE:



Groups



Herd identification



Manage your herd



Reporting on total sorts



Setting up sorts



Manage upcoming sorts

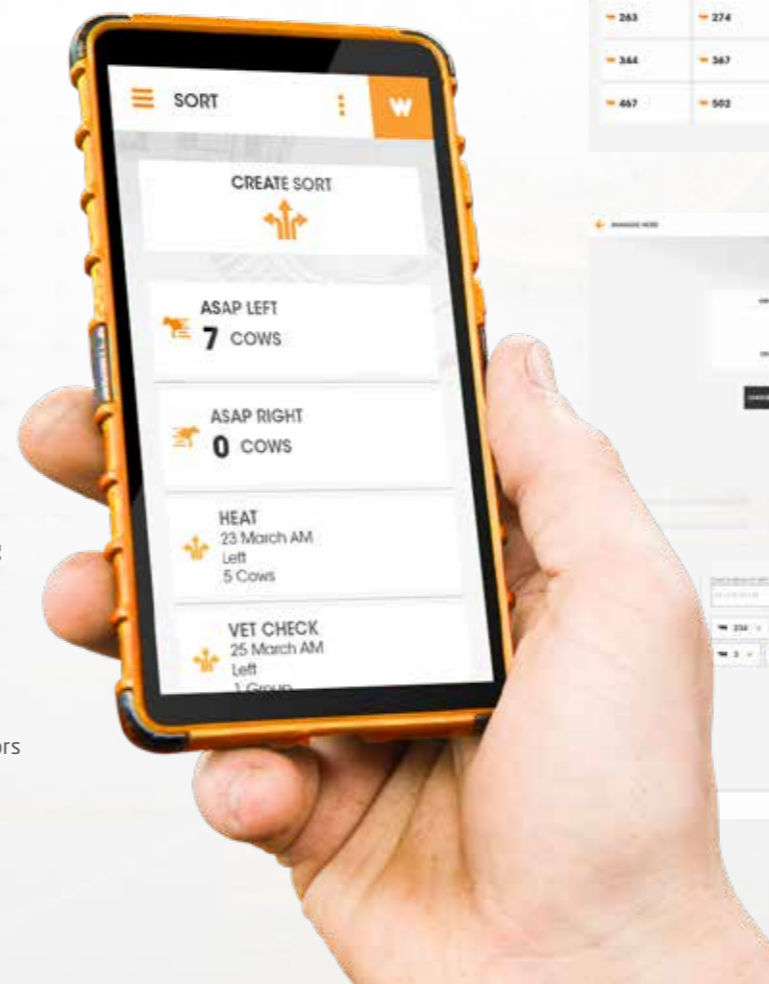

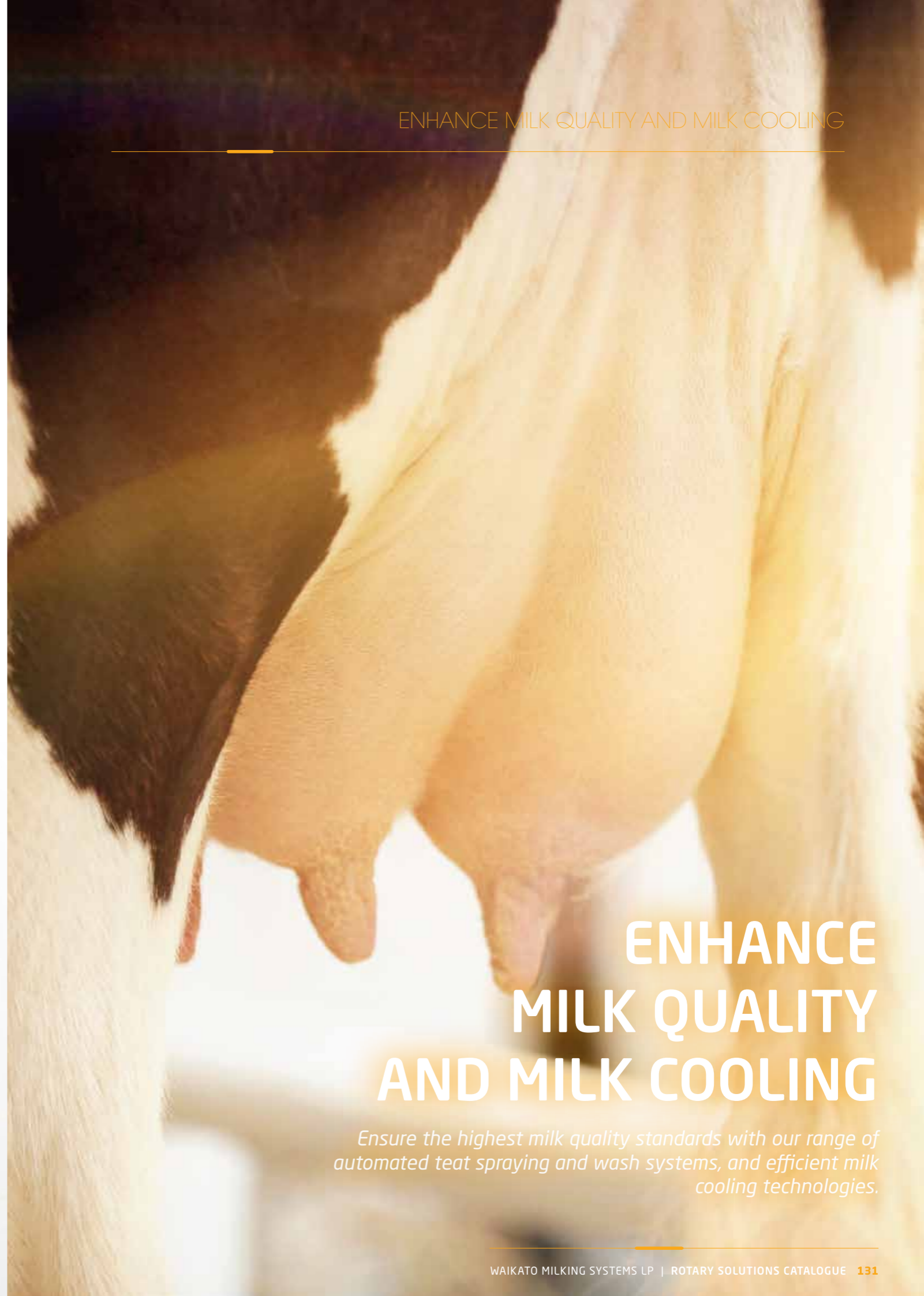

ENHANCE MILK QUALITY AND MILK COOLING

Ensure the highest milk quality standards with our range of automated teat spraying and wash systems, and efficient milk cooling technologies.

320 STANDARD MILKING CLUSTER

An entry-level milking cluster designed to optimise the milk harvesting process.



OPTIMISE YOUR MILK HARVESTING PROCESS WITH AN INDUSTRY PROVEN CLUSTER

The 320 Standard Cluster is an entry-level cluster that has been well proven in the market place for many years.

The Waikato Milking Systems' Standard Milking Cluster provides even milk extraction from each quarter for faster, more efficient milking.

Featuring large bore inlets and outlets to improve milk flow and evacuation, while ensuring a stable milking environment. The robust design of the Standard Milking Cluster optimises the milk harvesting process with a lower entry price.

ADVANTAGES

The Standard Milking Cluster provides optimised milk extraction.



Optimise your milk harvesting
Achieving even extraction from each quarter, faster, this ensures a more efficient milking.



High performance cluster
With stainless steel tops, suitable for large bore liners, the 320 Standard Milking Cluster, gives you the performance you need



Five year Claw warranty
The 320 Standard Milking Cluster offers a 5 year warranty on the Claw bowl, giving you peace of mind.



320 HIGH PERFORMANCE CLUSTER

Ergonomically designed for an all round better, more efficient milking.

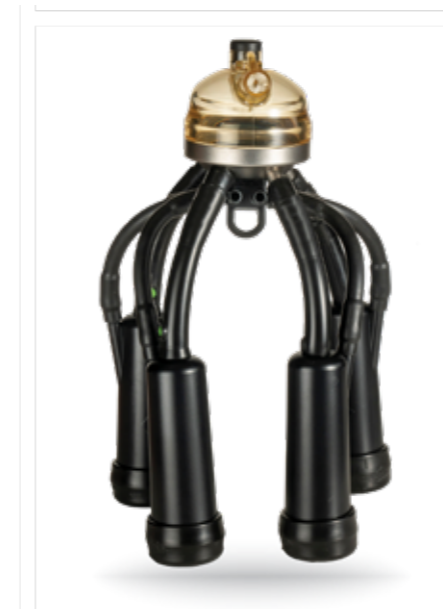

ERGONOMICALLY DESIGNED FOR OPTIMUM FIT AND ANIMAL COMFORT

The 320HP Milking Cluster has been designed to provide a reduced cluster weight, minimising operator fatigue. Teat condition and udder health is improved for teats of all sizes.

The perfect fit of the vented liner provides you with unsurpassed milk extraction and even milk flow from all quarters. The vented liner improves vacuum stability at high milk flow rates.

The unique design of the claw conforms to the latest cow genetics, with narrow rear inlets to improve cluster alignment and milk flow through the teat canal and high-capacity 5/8" and 3/4" outlet versions to effectively and efficiently move milk away from the teat end during liner closure. With its robust, lightweight and ergonomic design, the 320 High Performance Milking Cluster allows the vacuum, pulsation, liner, and the milking unit to work together to optimise the milk harvesting process.

ADVANTAGES

The 320 High Performance Milking Cluster allows you to achieve an optimal fit and healthier udders.



Ergonomically designed
Provides the optimum fit for cows of varying udder shapes and sizes, and easy handling for operators of all hand-sizes.



Reduces repetitive strain injuries
The 320HP Milking Cluster is super lightweight, significantly reducing the operator's risk of repetitive strain injuries (RSI)



25% lighter cluster design
Weights only 1.3kg (2.86 lb) with a 320ml (10.82fl.oz) claw bowl and comes with a 5 year unconditional bowl warranty



SMARTSPRAY AUTOMATED TEAT SPRAYING

Automated teat spraying that reduces your labour and increases your efficiency.

MAXIMUM TEAT COVERAGE, WITH MINIMAL LABOUR

SmartSPRAY is an innovative automatic teat spray system designed specifically for rotary dairies, that replaces the need for manual teat spraying and teat dipping before and after milking.

With no operator input required during milking, SmartSPRAY greatly reduces labour while ensuring maximum coverage regardless of the cow's position in the bail. The spray nozzles on the bullets can be rotated to cater for a wide variety of cow sizes and different breeds. The bullets are easy to clean and made of durable material designed to withstand years of harsh treatment under the cows at milking time.

The SmartSPRAY system is controlled directly by Waikato ECR-S or ECR Plus cup removers. When combined with Waikato Milking Systems cup removers SmartSPRAY can be set so it doesn't spray animals that are returning to the operator.

It's possible to fit the SmartSPRAY to other rotary systems using an interface to connect with other types of cup removers.

What's Included:

- **2 or 4 spray nozzles:** built into the Bullet leg spreader (per stall), 2 nozzles are standard, 4 are used for pre & post spraying
- **Electronic solenoid valve:** for accurate volume dispensing
- **On platform chemical storage vessel**
- **Off platform Chemical mixing vessel:** for safe and convenient premixing of spray
- **Pressure adjustable, air driven spray delivery pump:** to optimize spray delivery



ADVANTAGES

The SmartSPRAY system automates teat spraying to save time and labour.



Sprays every cow, every time
Reduces labour in the parlour while ensuring maximum coverage and optimum teat condition



Easier spraying, easier cupping
The spray system also acts as a leg spreader to make cupping easier



Pre-milking option
A pre-milking spray option is available (only with DairyHQ™ Dairy Management) which reduces labour



Bullet also works as a leg spreader to make cupping more effective



WALKOVERSPRAYER

Improve your teat spraying accuracy and reliability with the WalkoverSPRAYER's intelligent sensor technology.



THE AUTOMATIC TEAT SPRAYING SYSTEM TO ENSURE ACCURACY, EFFICIENCY & RELIABILITY

The WalkoverSPRAYER has been designed for herringbone and parallel dairies to accurately teat spray cows as they enter or exit the milking parlour to improve your efficiency and spray efficacy.

The system identifies individual cows and automatically adjusts the spray timing based on cow speed, to ensure accurate spray coverage regardless of how fast the cow is moving over the unit.

At a normal walking pace the WalkoverSPRAYER automatically deploys two spray nozzles to accurately spray all four teats, and deploys all four nozzles if the cows are moving faster.

The WalkoverSPRAYER suits small, medium and large-size dairies and solid panels can be fitted to the yard rails on each side of the unit to help prevent spray drift if the system will be located in a windy environment.

What's Included:

- **Sprayer unit:** With no moving parts, maintenance is reduced and ensures reliability and longevity.
- **Controller unit:** PCB Controller with push button adjustment.
- **Sensor:** Detects the cow and automatically deploys two or four spray nozzles depending on the speed of the cow through the raceway.



ADVANTAGES

The WalkoverSPRAYER uses intelligent sensor technology to ensure excellent coverage, every time.



Optical sensor technology for accurate coverage

Automatically deploys two or four spray nozzles according to the speed of the cows entering or exiting the milking parlour.



Automatic nozzle wash function

Reduces teat spray build-up and ensures that the nozzles are always clean and clear of contaminants.



Robust construction

Engineered from stainless steel with no moving parts for durability, reliability, longevity and performance.



WAIKATO SPRAY ARM

Automate your pre and post spraying routine for your rotary parlor, reducing labor costs.

ACCURATE AND RELIABLE, SAVING LABOR COSTS

The Waikato Spray Arm is a game changing automatic teat spraying system for large fast-moving rotaries.

The Waikato Spray Arm system allows for pre-spray and/or post-spray units to be installed, removing expensive labor units from your operation.

A series of advanced sensors accurately locate the cows position on the platform as she nears the exit / entry areas. This information is then communicated directly to the controller. The stall sensors determine the direction of the platform, measures the speed and activates a spray sequence. The cow sensor detects if there is a cow in the stall. No cow, no spray, no waste.

Thorough teat spray coverage of all four teats is achieved with the use of two independently controlled spray nozzles in each arm, that extend under the cows' udder as the rotary platform passes. The Spray Arm Controller can easily adjust the sequencing and spray volumes to suit your requirements.

Models available:

- **Waikato Spray Arm Exact:** Single spray arm mounted on a stationary pole. Sprays each stall as it passes. Suitable for 78 point and below. For speeds as fast as 5.5sec/stall.
- **Waikato Spray Arm Rapid Dual:** Two spray arms mounted on a stationary pole. Sprays each stall as it passes. Suitable for 80 points and above. For speeds as fast as 3.8sec/stall.

What's Included:

- **Spray Arm Exact:** Waikato Spray Arm, Touchscreen controller, teat spray pump, 24V DC power supply, sensors, brackets to mount the arms.
- **Spray Arm Rapid:** 2x Waikato Spray Arms, Touchscreen controller, teat spray pump, 24V DC power supply, sensors, slide assembly and mounting frame.

ADVANTAGES

The Waikato Spray Arm uses advanced sensor technology to ensure accurate spraying coverage, every time.



Easy to install

Easy to install and inexpensive to maintain.



Reliable and precise spray pattern.

Advanced sensors accurately locate the cow.



Affordable Automation

For large, fast moving rotaries.

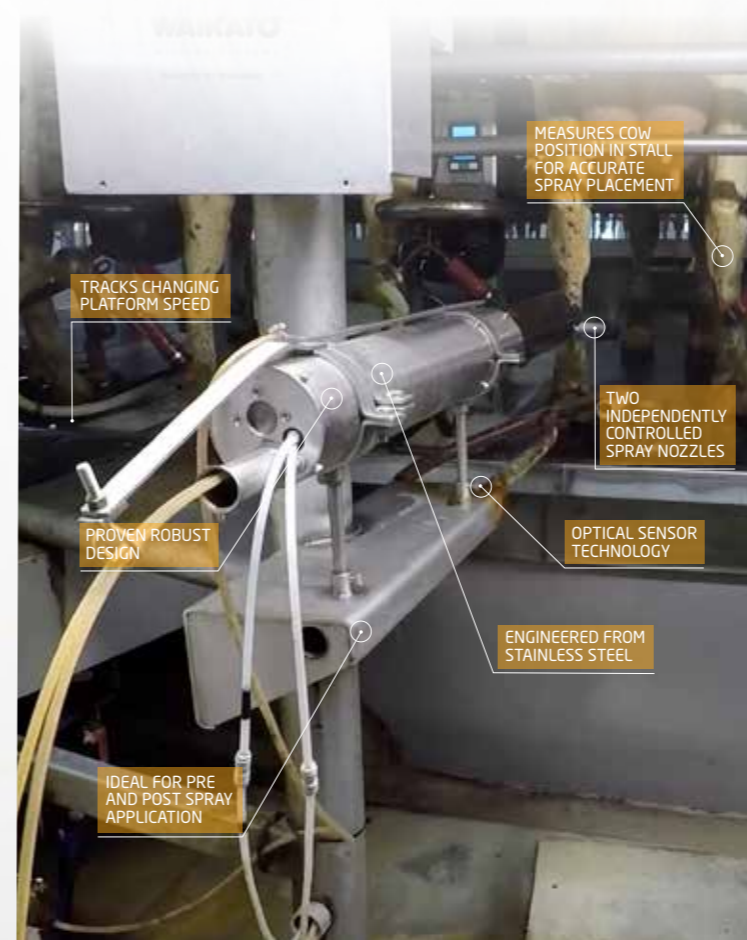

TRACKS CHANGING PLATFORM SPEED

MEASURES COW POSITION IN STALL FOR ACCURATE SPRAY PLACEMENT

TWO INDEPENDENTLY CONTROLLED SPRAY NOZZLES

PROVEN ROBUST DESIGN

OPTICAL SENSOR TECHNOLOGY

ENGINEERED FROM STAINLESS STEEL

IDEAL FOR PRE AND POST SPRAY APPLICATION

PLATE HEAT EXCHANGER

High-performance milk cooling, built to the highest standards.



BUILT TO HIGHER STANDARDS, TO LOWER YOUR MILK TEMPERATURE.

The Waikato Milking Systems Plate Heat Exchangers provide a high quality industrial grade cooling system to cool your milk within 3°C (37.4°F) of the primary water temperature.

The stainless steel double bank cooler is available in a range of sizes to suit herringbone and rotary milking systems. They are designed and assembled in New Zealand to meet ISO and MAF standards using 3A Accredited stainless steel and EPDM gaskets.

The Plate Heat Exchanges feature galvanised floor mount brackets and the clip-on gaskets allow for easy replacement.

ADVANTAGES

The Waikato Milking Systems Plate Heat Exchangers are built to the highest standards, for high-performance cooling.



A range of sizes and options
Wide range of sizes available for any milk flow from 3,000 to 11,000 litres per hour



Regulatory compliance
Manufactured from 3A Accredited stainless steel, and EPDM gaskets



Designed for convenience
Features floor mounted brackets and clip-on gaskets for easy replacement



SMARTWASH

A pre-programmed wash controller to save on labour and increase your efficiency.



A COMPREHENSIVE AND AUTOMATIC WASH, AT THE TOUCH OF A BUTTON

SmartWASH is a completely programmable automated wash system for your milking machine, with a selectable range of comprehensive wash scenarios.

With the versatility to manage any wash scenario for your plants requirements, SmartWASH enables you to meet all your hygiene standards and regulations. The SmartWASH controller has been designed to provide total flexibility and constant reliability, and the modern touchscreen technology ensures a simple and user-friendly interface for the operator.

At the touch of a button you can select a wash scenario to suit your requirements and manage an efficient cleaning regime for your milking system. When using a SmartWASH system, this means there is no requirement for operators to be handling chemicals.

ADVANTAGES

The SmartWASH system's programmed wash scenarios save time and labour.



Automatic wash control
Selectable wash scenarios created from a comprehensive menu, at the touch of a button



Day by day programming
A repeatable, efficient and reliable wash cycle every time



Programmable acid, alkali or sanitiser washes
Accurate detergent dispensing minimises cleaning chemical wastage



ICE BANK REFRIGERATION UNIT

Maximise your milk cooling efficiency, while minimising the space required.

A SMALLER FOOTPRINT, THAT'S BIGGER ON EFFICIENCY.



The small footprint means the Ice Bank can easily be accommodated in existing dairy parlours, and are ideal for herds of up to 600 cows - but can also be sized for larger herd sizes.

The Ice Bank manufactures ice between milkings with little or no impact on electricity supply, and minimises the amount of water required.

Milk enters the milk silo at the New Zealand industry standard*, generally around 6°C (42.8°F), but can enter the silo from 5°C (41°F) depending on the farm's logistics. Existing units can sometimes be used to run the Ice Bank and cool the milk once it has entered the silo. Smaller sized systems are delivered to site, tested and filled with refrigerant, greatly reducing the cost of an initial installation.

* All markets have their own local cooling standards that need to be met

ADVANTAGES

The Ice Bank maximises your milk cooling efficiency, while minimising your water and power requirements.



Small footprint to suit most farms
Easily installed on the majority of farms, the unit can be accommodated in most existing dairy parlours.



Minimum water requirement
The unit requires a minimum amount of water making it ideal for farms with a limited water supply.



Reduced power load
Ice is manufactured between milkings to avoid unnecessary load on the power supply.



WATER CHILLING REFRIGERATION UNIT

Fast and efficient milk cooling, that can be fitted to existing water tanks.

A WATER CHILLING SOLUTION, FOR ALL FARM SIZES.



Suitable for all dairy farm sizes, the Water Chiller requires sufficient space to accommodate a water tank and water chilling unit - and depending on the volume of milk per milking the water tank size can vary from 10,000 to 30,000 litres (2,600 to 7,900 gallons).

The size of the Water Chiller unit and volume of the water tank determines how long it takes to bring the water in the tank down to the recommended temperature - often around 6°C (42.8°F) enabling milk to enter the milk vat at around 9°C (48.2°F).

The chiller on the vat then reduces and maintains the milk temperature to the New Zealand industry standard*, generally between 4°C and 6°C (39.2°F and 42.8°F). Similar to Ice Banks, the unit chills milk between milkings with little or no impact on electricity supply - with the chilled water cooling the milk through the on-farm plate cooler.

* All markets have their own local cooling standards that need to be met

ADVANTAGES

The Water Chiller cools quickly and efficiently, while reducing your power load.



Suitable for all farm sizes
The system can easily be installed on any farm, of any size.



Retrofit to existing water tanks
The unit can be fitted to existing water tanks on your farm.



Reduced power load
Operates between milkings for minimal, or no impact, on electricity supply.



GLYCOL CHILLING REFRIGERATION UNIT

Minimise your milk cooling costs by maximising your energy efficiency.



SIMPLE AND EFFICIENT MILK COOLING, IN A SNAP.

Glycol Snap Chilling units are ideal for large, continuous 24/7 farming operations, new parlours with 6+ hour milkings, or large herd farms - due to the specific levels of electricity required.

Powered by inverter technology, Glycol Snap Chilling units are able to ramp up to match the load required and deliver power savings of up to 40% over standard compressors.

Each Glycol unit is sized to ensure the milk temperature is approximately 6°C (42.8 °F) when it enters the milk silo - and a backup unit on the base of the silo is recommended to maintain the milk to the industry standard. The milk is then easily maintained at temperature by the silo chiller.

Glycol chilling can also be supplied with standard DOL compressor start technology.

ADVANTAGES

The Glycol Snap Chilling system maximises energy efficiency for larger farming operations.



Reliable and efficient

The units provide low milk entry temperature of 6°C (42.8°F) before it enters the milk silo.



Maximum energy efficiency

Inverter technology provides power savings of up to 40% over standard compressors.



Sizes to suit all farms

The system can be installed on all farm sizes and are ideal for large 24/7 operations.



MILK SILO CHILLING REFRIGERATION UNIT

Maximise your milk cooling efficiency while minimising your upgrade costs.



COST-EFFECTIVE AND EFFICIENT MILK COOLING, IN THE VAT.

Milk Silo Chilling is a cost-effective option for farms whose milk is collected every other day.

The Milk Silo Chilling system chills milk once it is in the milk silo, and utilises inverter compressors and electronic valves to ensure precise load matching and maximum energy efficiency.

Vertical air discharge, with Variable Speed Fan Drive, maximises heat rejection regardless of the wind direction - optimising performance in all ambient temperatures.

Chiller efficiency to chill milk below 10°C (50°F) is affected by water temperature. The Milk Silo Chilling system can be easily retrofitted into existing dairy parlours between milkings.

ADVANTAGES

Milk silo chilling minimises your set-up costs while maximising your energy efficiency.



Industry standard milk cooling

Enables efficient chilling of milk in the vat to meet industry standard cooling regulations.



Retrofit to existing units

Ideal for upgrades to existing units on the farm milk vat.



Maximum energy efficiency

Inverter technology maximises energy efficient with precise load matching.



OUR GUARANTEE TO YOU

Create a clean and efficient milking environment with the Orbit 2500 base model milking system.



WE PROMISE.....That your Waikato Milking System will be installed to exacting standards, will meet all industry criteria and will operate to the high performance standards we demand. There fore we are able to offer you our comprehensive guarantee.

How does the Waikato Milking Systems guarantee work? Its simple, its PEACE OF MIND.

You have a guarantee from Waikato Milking Systems that we will stand behind your purchase. In the unlikely even that you experience a problem with you purchase we will, together with the installing dealer do whatever is necessary to rectify your concerns. For specific product failures you are covered by our 12/24 warranty. That is 12 months parts and labour and 24 months warranty on parts.

You must ensure that your machine is serviced as per the recommendations and only use Waikato Milking Systems 100% genuine parts. Service work must be carried out by an approved Waikato Milking Systems dealer.

THINGS YOU NEED TO CONSIDER

- Building permits
- Site approval
- Building
- Painting of building
- Drainage to ponds / effluent
- Drains under receiver, vat and wash tub
- Yard - circular or rectangular
- Vet holding yard
- Loading race
- Service tunnel under platform
- Backing gates - water or electric
- Steelwork around yards
- Platform type - concrete, composite or steel
- Milking machine
- Compressor
- Water works
- Shed reticulation
- Wash water recirculation from vats
- Hot water cylinders
- Wash down points around the dairy
- Yard boom
- Water for backing gate
- Wash down and sump pumps
- Cooler pump
- Machine and vat wash systems
- Vat wash pump
- Farm water supply
- Toilet - sewage
- Effluent disposal around the farm
- Teat spray systems
- Sorting gate systems
- Drenching systems
- Feed systems on the platform
- Electrical work
- Power to the site
- Transformer sizing
- Tanker track position
- Site works
- Refrigeration

PLANNING YOUR DAIRY

Have you thought of all the steps that are involved...

- 1 EXPERIENCE THE WAIKATO MILKING SYSTEMS DIFFERENCE**
Visiting existing Waikato Milking Systems dairies is a great way to experience the Waikato Milking Systems difference and gain insight to the technologies and dairy layouts which will work for you. Your local Waikato Milking Systems representative or dealer will introduce you to farm owners in your area.
- 2 PERMITS AND CONSENTS**
There are many regulations you must follow when building a new dairy and these vary between regions and countries. Your local Waikato Milking Systems representative or dealer understands the requirements and will be able to assist you.
- 3 CHOICE OF CONTRACTORS**
Meet as many contractors as possible and ask for estimates to budget with. Select a few contractors that you would like formal quotes from and choose those who will be best to work with.
- 4 PLAN THE DESIGN**
Draw up some concepts and discuss these with your contractors so they can do some preliminary plans for approval. Make sure you discuss your requirements clearly so you know exactly what you are getting for your money.
- 5 REVIEW YOUR BUDGET**
A reassurance, when buying from Waikato Milking Systems, is that if your new build budget will not allow your wish-list of technology, our modular and integrated system will allow you to retrofit various elements as you can afford them.
- 6 MANAGING YOUR CONSTRUCTION**
The variety of elements which need to be considered, and undertaken, in order and to time (avoiding unnecessary delays and additional cost) usually require the services of a project manager. Talk to your local Waikato Milking Systems representative, dealer or a preferred contractor about the best person for this job on your farm.
- 7 STAFF TRAINING**
Your Waikato Milking Systems representative or dealer will spend time with you to ensure you and your staff are familiar with all aspects of your new dairy.
- 8 ONGOING USE AND MAINTENANCE**
Establishing good processes takes time and they need to be regularly reviewed. Your Waikato Milking Systems representative or dealer will be able to help you with a maintenance plan to ensure the longevity of your new plant.

ARE YOU READY TO GROW THE VALUE OF YOUR DAIRY?

Our range of rotary milking systems and technology solutions have been designed to maximise your herd performance and productivity, and maintain the health and well-being of your animals.

To find out more about how we can grow the value of your dairy, contact one of our experts near you, or visit www.waikatomilking.com



GLOBAL HEADQUARTERS

T: +64 7 849 8755 **F:** +64 7 849 5923

29 Innovation Way | Northgate Business Park, Horotiu | Hamilton, New Zealand

PO Box 20325, Hamilton 3241 | New Zealand | customerservice@waikatomilking.com

AUSTRALIAN OFFICE

G11/61 Mackenzie Street, Melbourne, VIC 3000

customerservice@waikatomilking.com

UK OFFICE

JB Wheaton & Sons Ltd, Chard Junction, Somerset, TA20 4QN

customerservice@waikatomilking.com

IRELAND OFFICE

Waikato Milking Systems Ireland Limited, Glenmaquin, Letterkenny, Co Donegal, F92X8C1

customerservice@waikatomilking.com

USA OFFICE

Waikato Milking Systems USA

275 Investment Court, Verona, Wisconsin 53593, USA

Phone toll free: +1. 866 648 6455

CHINA OFFICE

Waikato Milking Systems China

No., Room 315, Third floor of Zhongtai International.

269 Fuyupo Village, Sanjianfang Township,

Chaoyang District, Beijing

customerservice@waikatomilking.com
